

the DXLab Suite

2012-01-12 v1.3

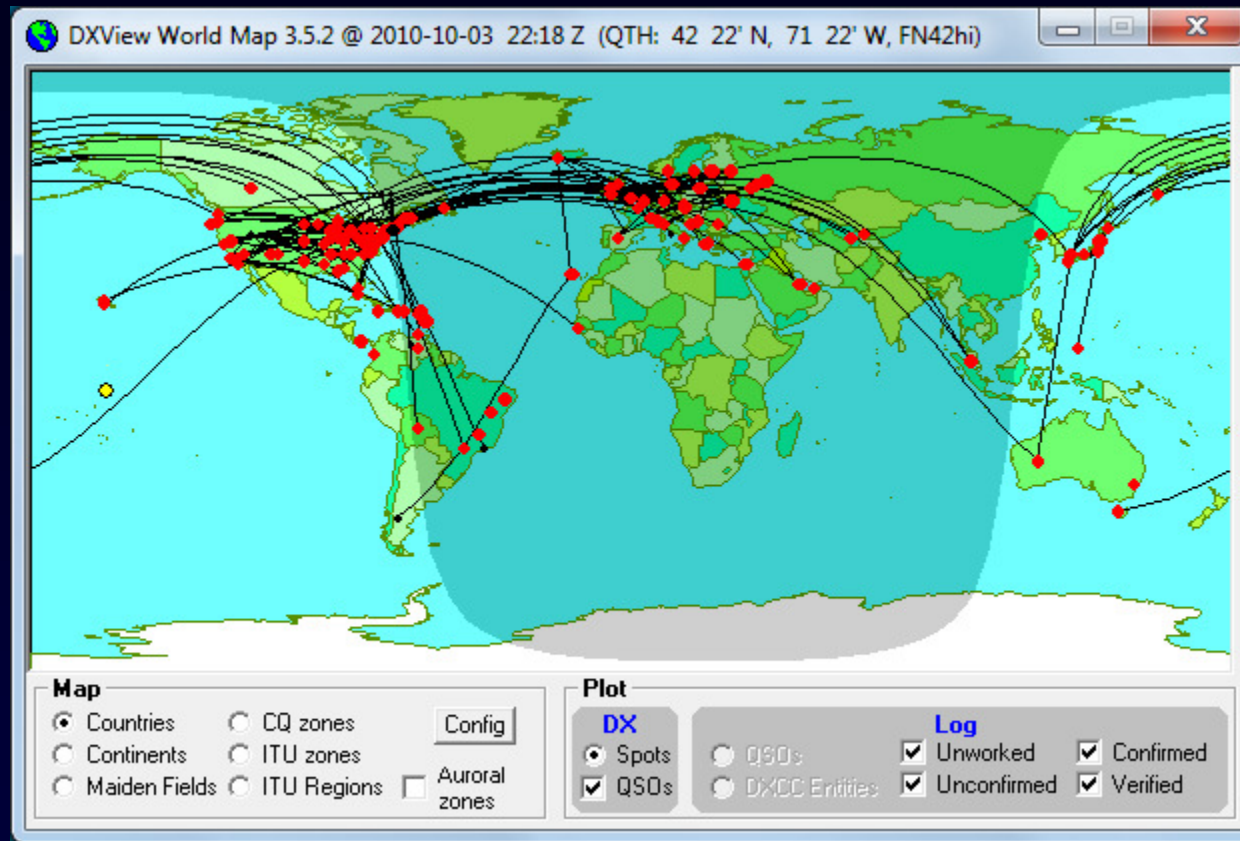

Better DXing Through Software

the DXLab Suite

Eight free applications that run individually

but

when run simultaneously sense each other's presence

and

interoperate automatically

Better DXing Through Software

Original Architecture: Monolithic

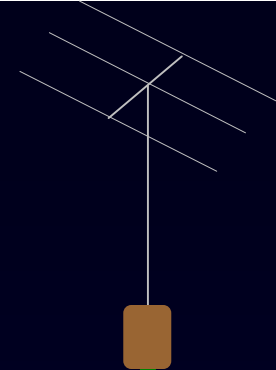

DXLab

Transceiver Control

Logging

Propagation

Location Control

DX Spot Collection

QSL Routes

Re-architecture (2000): Modular

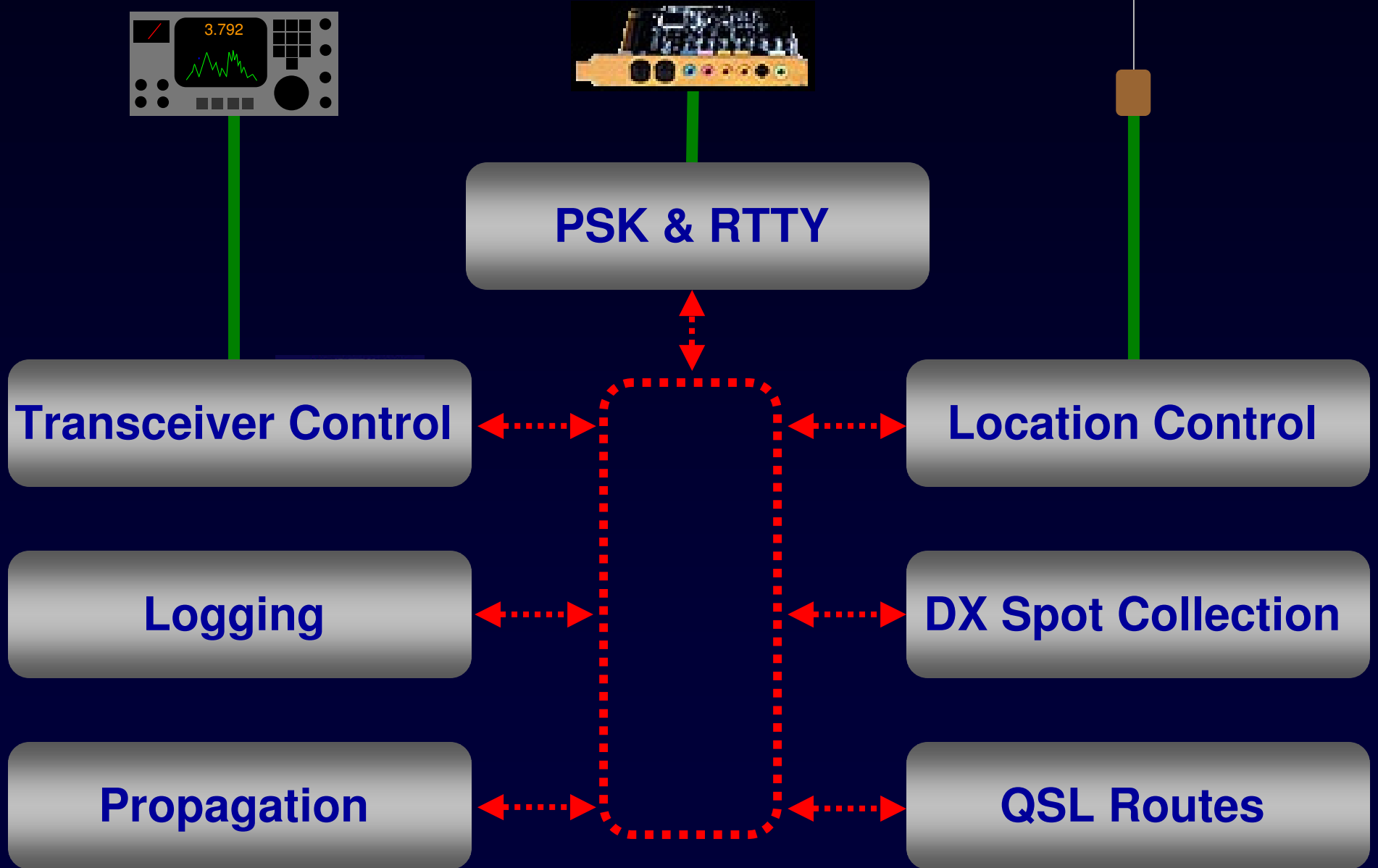

the DXLab Suite

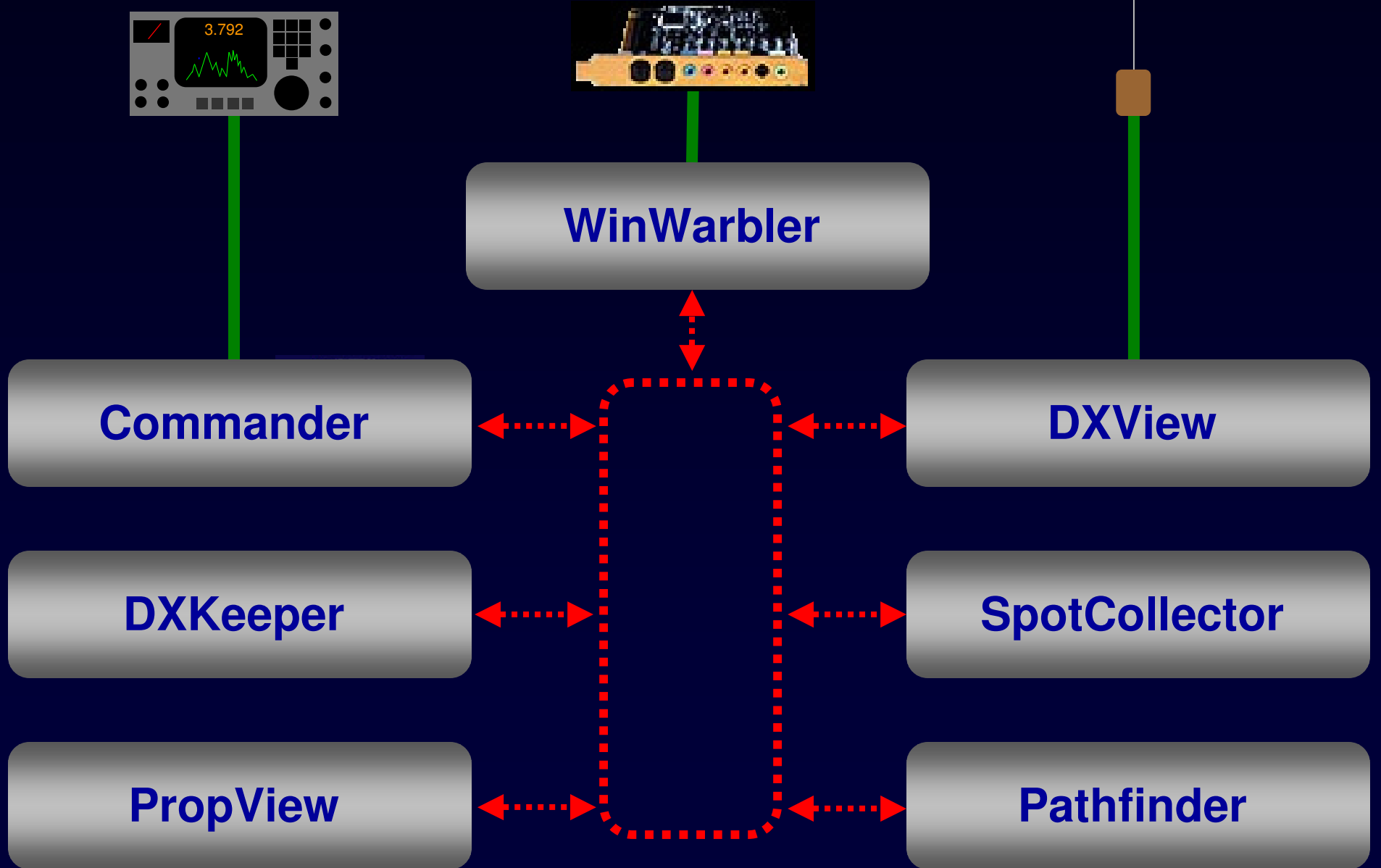

A Suite of Interoperating DXing Applications

DXKeeper 8.9.4 [CC,DXV,SC,WW] - AA6YQ.mdb : 18487 QSOs

Log QSOs | QSL | Check Progress | my QTHs | Import QSOs | Export QSOs

QSO: Jordan
 call JY4NE name QTH
 mode RTTY via tx freq 14.086765 begin 9/20/2010 18:37
 sent 599 rcvd 599 tx band 20M rx freq 14.086764 end 9/20/2010 18:37
 power 1500 code 342 DXCC JY entity Jordan

Call	DXCC	Starting UTC	Band	Mode	Sent	Rcvd	Name
JT5DX	JT	9/19/2010 23:23	17M	CW	599	599	hadraabal
PX0AT	UA	9/20/2010 01:01	20M	RTTY	599	599	Vit
KP4JFR	KP4	9/20/2010 01:11	20M	RTTY	599	599	Jose
JY4NE	JY	9/20/2010 18:37	20M	RTTY	599	599	

SpotCollector 5.3.9 @ 2010-10-04 19:59 Z [CC,DXK,DXV,WW] (log: AA6YQ.mdb)

WVWV 10-04 1806 Z | Outgoing spot | Spot source status

Callsign	Pfx	Freq	Band	Mode	LastTime	Notes	NAE	NAM	NAW	SA	EU	AF	AS	OC	UN	LastOrig	Source
PS7DX	PY	14.018.3	20M	CW	10/4/2010 19:59	CQ 8 dB 21 WPM	Y	Y	Y	Y	Y	Y	Y	Y	Y	NA-E	N4ZR-#
SQ9CNS	SP	3.541.0	80M	CW	10/4/2010 19:59	CQ 16 dB 13 WPM	Y	Y	Y	Y	Y	Y	Y	Y	Y	EU	DL5Q-#
LA3TQ	LA	14.017.8	20M	CW	10/4/2010 19:59	CQ 18 dB 23 WPM	Y	Y	Y	Y	Y	Y	Y	Y	Y	EU	S5Z-#
IK0RCD	I	14.025.6	20M	CW	10/4/2010 19:59	CQ 13 dB 18 WPM	Y	Y	Y	Y	Y	Y	Y	Y	Y	NA-M	K8ND-#
3A/SP9EVP	3A	7.017.0	40M	CW	10/4/2010 19:59	CQ 21 dB 26 WPM	Y	Y	Y	Y	Y	Y	Y	Y	Y	EU	DL5Q-#
UA9MA	UA0	1.822.5	160M	CW	10/4/2010 19:59	CQ 10 dB 25 WPM	Y	Y	Y	Y	Y	Y	Y	Y	Y	EU	EI6IZ-#

DXView World Map 3.5.2 @ 2010-10-04 19:57 Z (QTH: 42 22' N, 71 22' W, FN42h)

Map: Countries, Continents, Maiden Fields, CQ zones, ITU zones, ITU Regions, Auroral zones, DX, Spots, QSOs, DXCC Entities, Unworked, Confirmed, Unconfirmed, Verified

WinWarbler 6.8.5 for AA6YQ @ 2010-10-04 19:59 Z [CC,DXK,DXV,SC]

QSO Info (Receive Pane 0) | local: 2010-10-05 00:59 | Xcvr Freq

Call: EY7AD | Name: Rakhim | DXCC: EY | Begin: Log | X | Rx: 14,086.19

QSL: via DIRECT-1 | CQ: 17 | ITU: 30 | QTH: 735700 | Cont: AS | End: Spot | Tx: 14,086.19

Buro: Grid: MN30 | Pri sub: | Sec sub: | Comment: | Config | Help

QU0THCQ DX CQ DX DE SV1PAS SV1PAS PSE K
 DS1PAUSSVPAS DEHPFF,PD1BPSE K...
))ITCQ DX CQ DX DE SV1PAS SV1PAS PSE EUU0E0SCQ DX CQ DX DE SV1PAS SV1PAS PSE K
 S MSOVAS UV1PAS DE PD1ANB,PD1ANB
 PSE K...9R2 QR2 QR2 DE SV1PAS SV1PAS PSE K

Commander 8.5.8 [Icom IC-7200] @ 19:59:42 Z 14,086.19 LSB

VFO A: 20M | VFO B: 21,008.10

Filters: Group normal | Width: 0 | PBT 1: 50 | PBT 2: 50

AL-1200 | Plate: 7.75 | Load: 4 | Band: 20

Mode: LSB | LSB (normal) | USB (normal) | CW (narrow) | CW-R (narrow) | FM (wide) | AM (wide) | RTTY (wide) | RTTY-R (wide)

dx Commander

Range: 1 5 10 25 50 100

14,088.5
 14,088.0 E17BFB
 14,087.5 EA4AHE
 14,087.0
 14,086.5 UR7ITU
 14,086.0
 14,085.5 PF7DKW
 14,085.0 LX8RTTY
 14,084.5 SP9GKJ
 14,084.0

Band: 160 80 60 40 30 20 17 | 15 12 10 6 4 2 .7

Spotcollector | Config | Help

Macros: rty sample

F5: CQ | F6: Call | F7: Over | F8: SK log | ALT | F9: ur rpt | F10: tu log grz? | F11: de mgcall | F12: mgcall (3)

RTTY receive (soundcard) | RTTY transmit (soundcard)

RTTY receive: Freq: 14,084.065 | Signal level & squelch: 61

RTTY transmit: Freq: 14,084.065 | net | Reverse | Start | Stop | Abort

Operating Mode: CW, PSK31, Phone, PSK63, RTTY, PSK125

Tuning Display: Vert height: 2.0 | Horiz zoom: 1 | Horiz pan: 14086

Single Point of Control: DXLab Launcher



Development Drivers

1. User-driven iterative development

- Open Yahoo group with ~3600 participants
- Defect repairs get highest priority; goal is < 24 hours
- Public enhancement lists
- Closed source, one developer
- Frequent releases
 - Full releases for first-time installation
 - Incremental updates for defect repairs and enhancements
 - Automated installation and updates

2. Easy to Use AND Powerful

Automated Installation and Updates: Apps

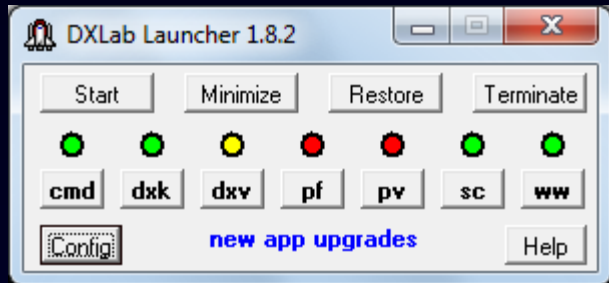

Automated Installation and Updates: Apps

DXLab Launcher Configuration [AA6YQ] - new app upgrades available

Distribution site: DXLabSuite

Install folder pathname:

Browser pathname:

Auto Start Minimize After Start

Always On Top Workspaces On Startup

Shutdown After Terminate

Terminate On Shutdown

Check for New each day

Use Dual Monitors

Log Debugging Information

Apps Started Before DXLab Apps | **DXLab Apps** | Apps Started After DXLab Apps

Application	Enab	Program Path	Installed	Avail	Action	Registry
Commander	<input checked="" type="checkbox"/>	C:\DXLab\Commander\CI-V Commander.exe <input type="button" value="Sel"/>	8.5.5	8.5.8	<input type="button" value="Upgrade"/>	Sv Ld
DXKeeper	<input checked="" type="checkbox"/>	C:\DXLab\DXKeeper\DXKeeper.exe <input type="button" value="Sel"/>	8.9.1	8.9.1	<input type="button" value="Restore"/>	Sv Ld
DXView	<input checked="" type="checkbox"/>	C:\DXLab\DXView\DXView.exe <input type="button" value="Sel"/>	3.4.7	3.4.7	<input type="button" value="Restore"/>	Sv Ld
Launcher	<input checked="" type="checkbox"/>	C:\DXLab\Launcher\DXLabLauncher.exe <input type="button" value="Sel"/>	1.8.2	1.8.2	<input type="button" value="Restore"/>	Sv Ld
Pathfinder	<input checked="" type="checkbox"/>	C:\DXLab\Pathfinder\Pathfinder.exe <input type="button" value="Sel"/>	4.7.6	4.7.6	<input type="button" value="Restore"/>	Sv Ld
PropView	<input checked="" type="checkbox"/>	C:\DXLab\PropView\PropView.exe <input type="button" value="Sel"/>	1.4.9	1.4.9	<input type="button" value="Restore"/>	Sv Ld
SpotCollector	<input checked="" type="checkbox"/>	C:\DXLab\SpotCollector\SpotCollector.exe <input type="button" value="Sel"/>	5.3.8	5.3.8	<input type="button" value="Restore"/>	Sv Ld
WinWarbler	<input checked="" type="checkbox"/>	C:\DXLab\WinWarbler\WinWarbler.exe <input type="button" value="Sel"/>	6.8.3	6.8.3	<input type="button" value="Restore"/>	Sv Ld

Startup parameters: DXKeeper Log

Automated Installation and Updates: Databases

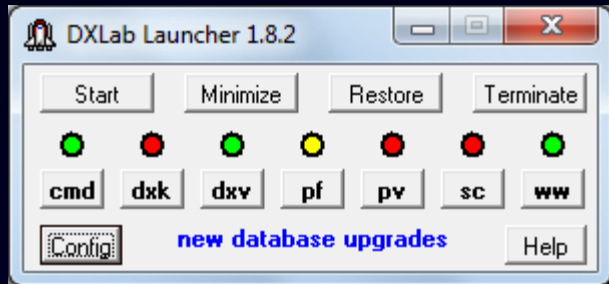

Automated Installation and Updates: Databases

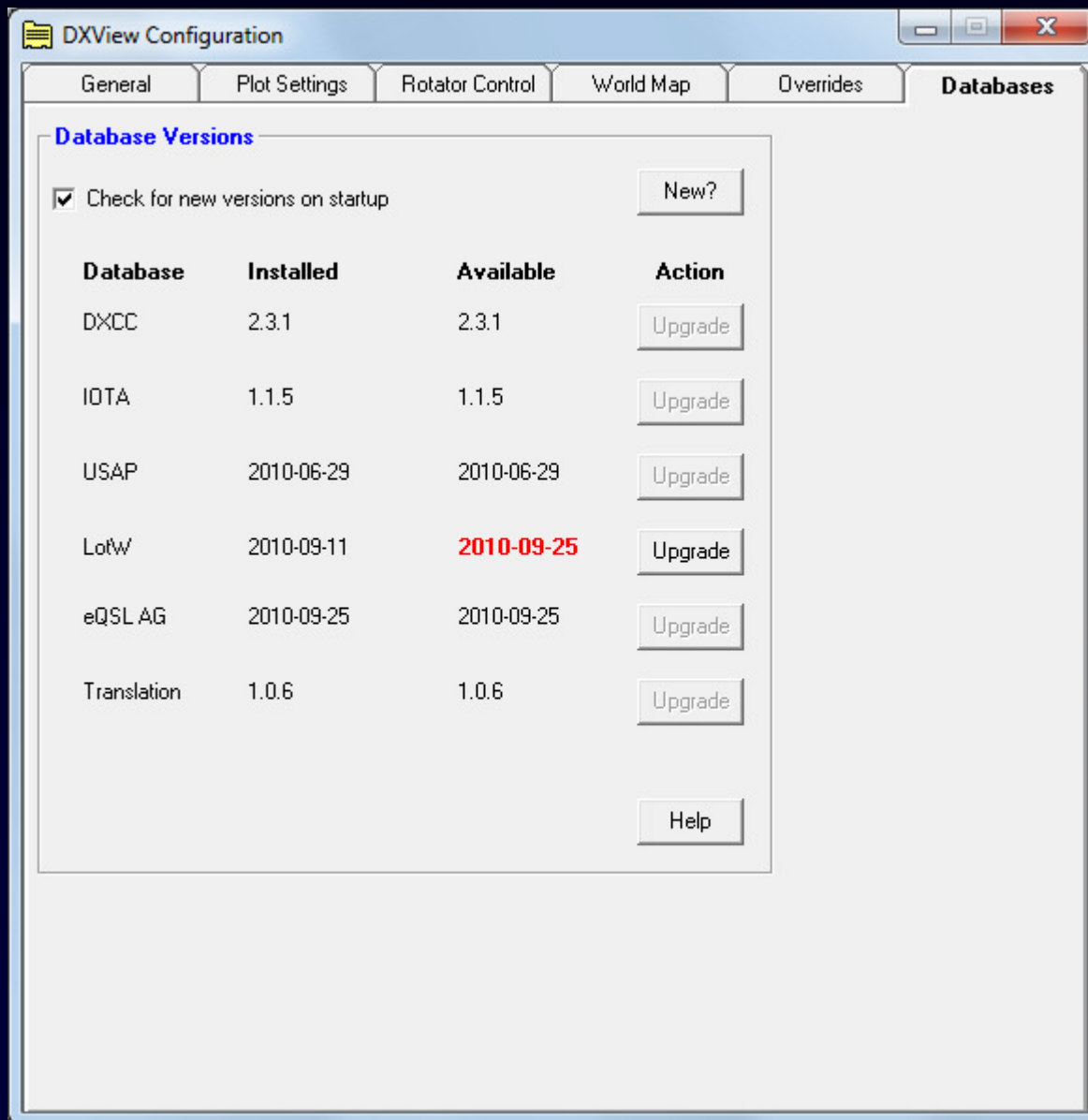

Development Drivers

1. User-driven iterative development

2. Easy to Use AND Powerful

- No menus
- Graphical Controls with popup explanations
- Online and PDF reference documentation
- Online step-by-step explanations (Wiki)
- User feedback from frequent releases
 - Improves usability
 - Improves documentation

Documentation: Online Reference

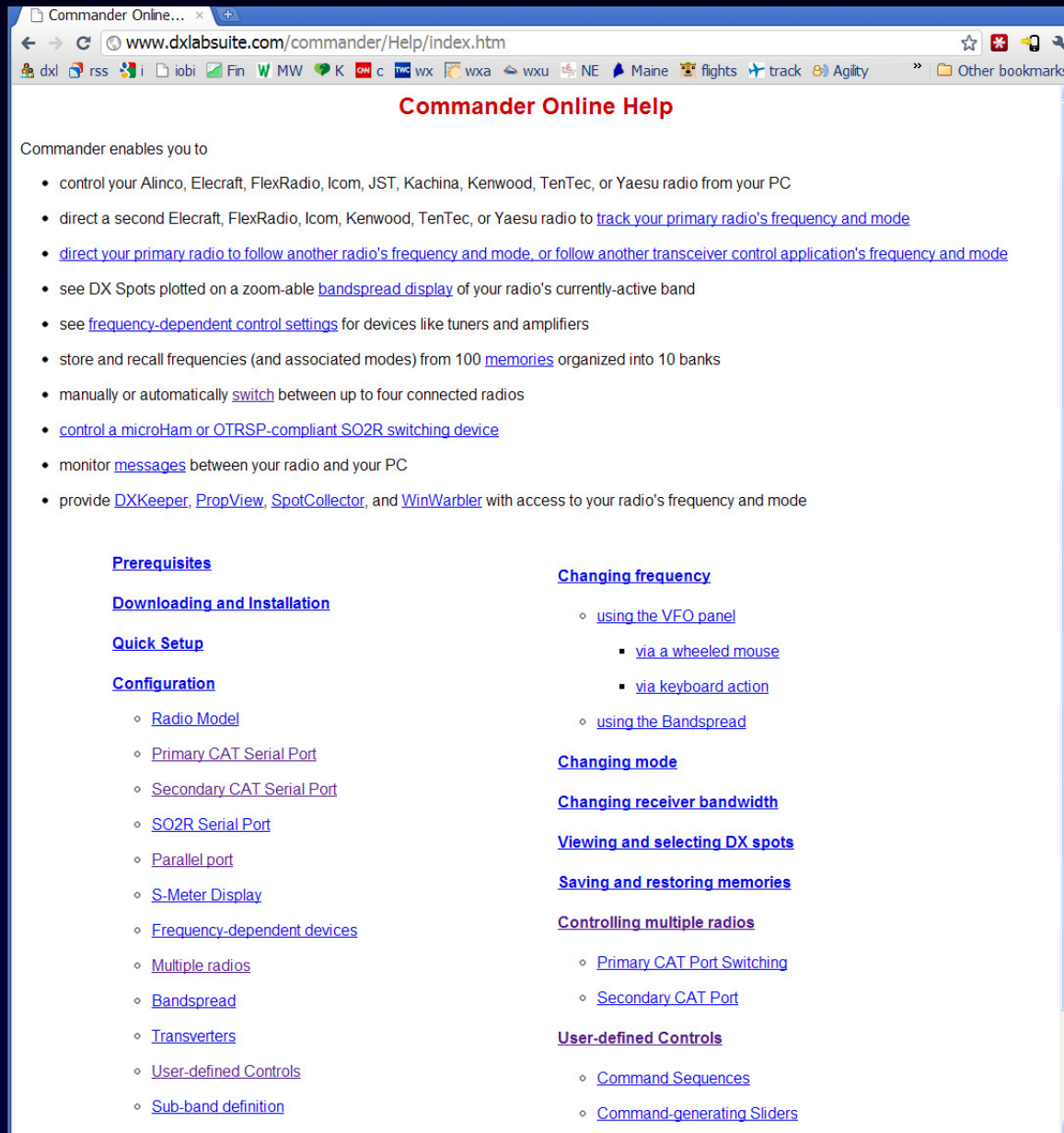

The screenshot shows a web browser window with the address bar displaying www.dxlabsuite.com/commander/Help/index.htm. The page title is "Commander Online Help". The main content area begins with the text "Commander enables you to" followed by a list of features and capabilities. Below this list, the page is organized into two columns of links. The left column contains sections: "Prerequisites", "Downloading and Installation", "Quick Setup", and "Configuration". The right column contains sections: "Changing frequency", "Changing mode", "Changing receiver bandwidth", "Viewing and selecting DX spots", "Saving and restoring memories", "Controlling multiple radios", and "User-defined Controls". Each section contains a list of sub-links.

Commander Online Help

Commander enables you to

- control your Alinco, Elecraft, FlexRadio, Icom, JST, Kachina, Kenwood, TenTec, or Yaesu radio from your PC
- direct a second Elecraft, FlexRadio, Icom, Kenwood, TenTec, or Yaesu radio to [track your primary radio's frequency and mode](#)
- [direct your primary radio to follow another radio's frequency and mode, or follow another transceiver control application's frequency and mode](#)
- see DX Spots plotted on a zoom-able [bandspread display](#) of your radio's currently-active band
- see [frequency-dependent control settings](#) for devices like tuners and amplifiers
- store and recall frequencies (and associated modes) from 100 [memories](#) organized into 10 banks
- manually or automatically [switch](#) between up to four connected radios
- [control a microHam or OTRSP-compliant SO2R switching device](#)
- monitor [messages](#) between your radio and your PC
- provide [DXKeeper](#), [PropView](#), [SpotCollector](#), and [WinWarbler](#) with access to your radio's frequency and mode

Prerequisites

Downloading and Installation

Quick Setup

Configuration

- [Radio Model](#)
- [Primary CAT Serial Port](#)
- [Secondary CAT Serial Port](#)
- [SO2R Serial Port](#)
- [Parallel port](#)
- [S-Meter Display](#)
- [Frequency-dependent devices](#)
- [Multiple radios](#)
- [Bandspread](#)
- [Transverters](#)
- [User-defined Controls](#)
- [Sub-band definition](#)

Changing frequency

- [using the VFO panel](#)
 - [via a wheeled mouse](#)
 - [via keyboard action](#)
- [using the Bandspread](#)

Changing mode

Changing receiver bandwidth

Viewing and selecting DX spots

Saving and restoring memories

Controlling multiple radios

- [Primary CAT Port Switching](#)
- [Secondary CAT Port](#)

User-defined Controls

- [Command Sequences](#)
- [Command-generating Sliders](#)

Documentation: PDF Reference

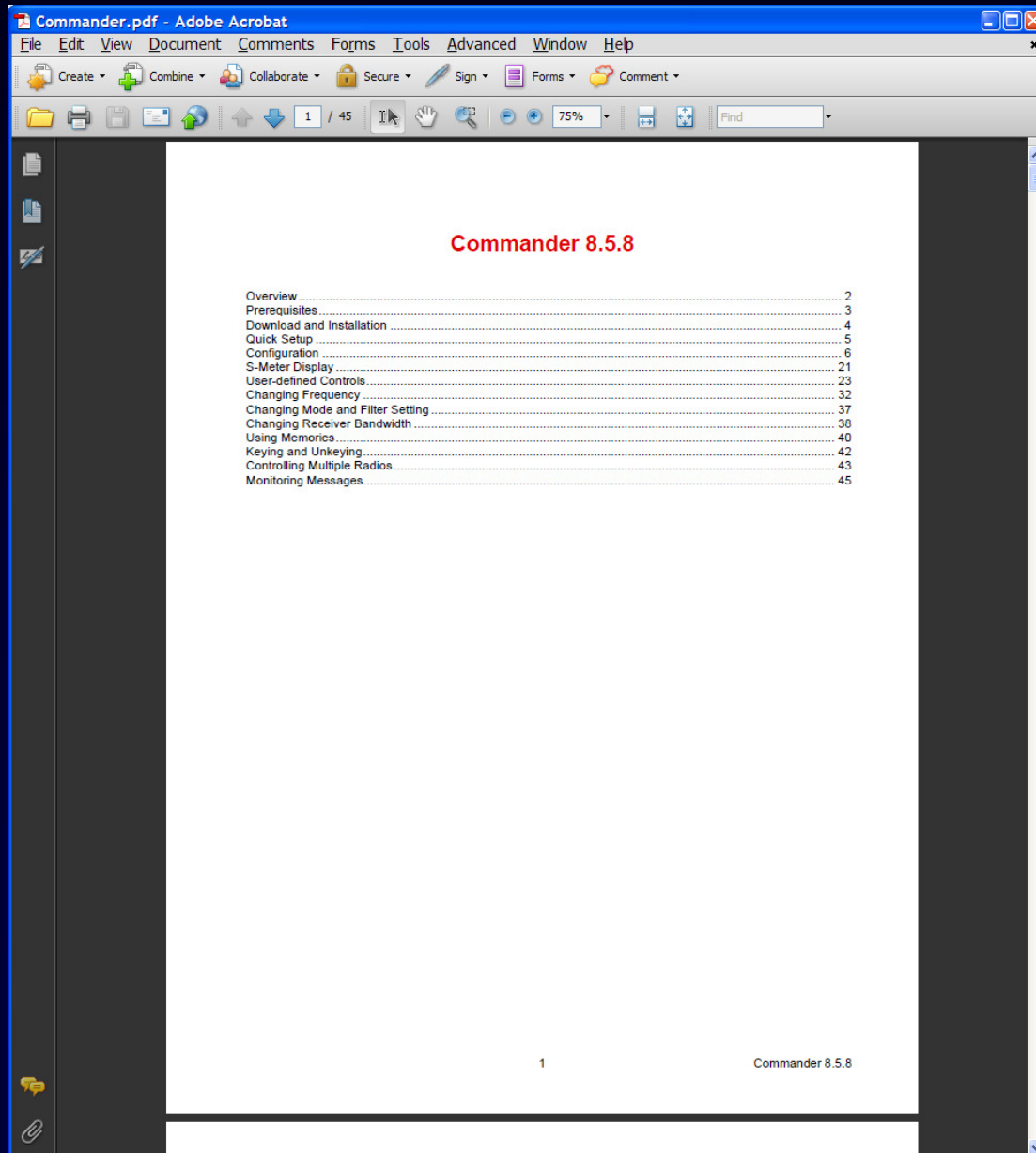

Documentation: Step-by-Step

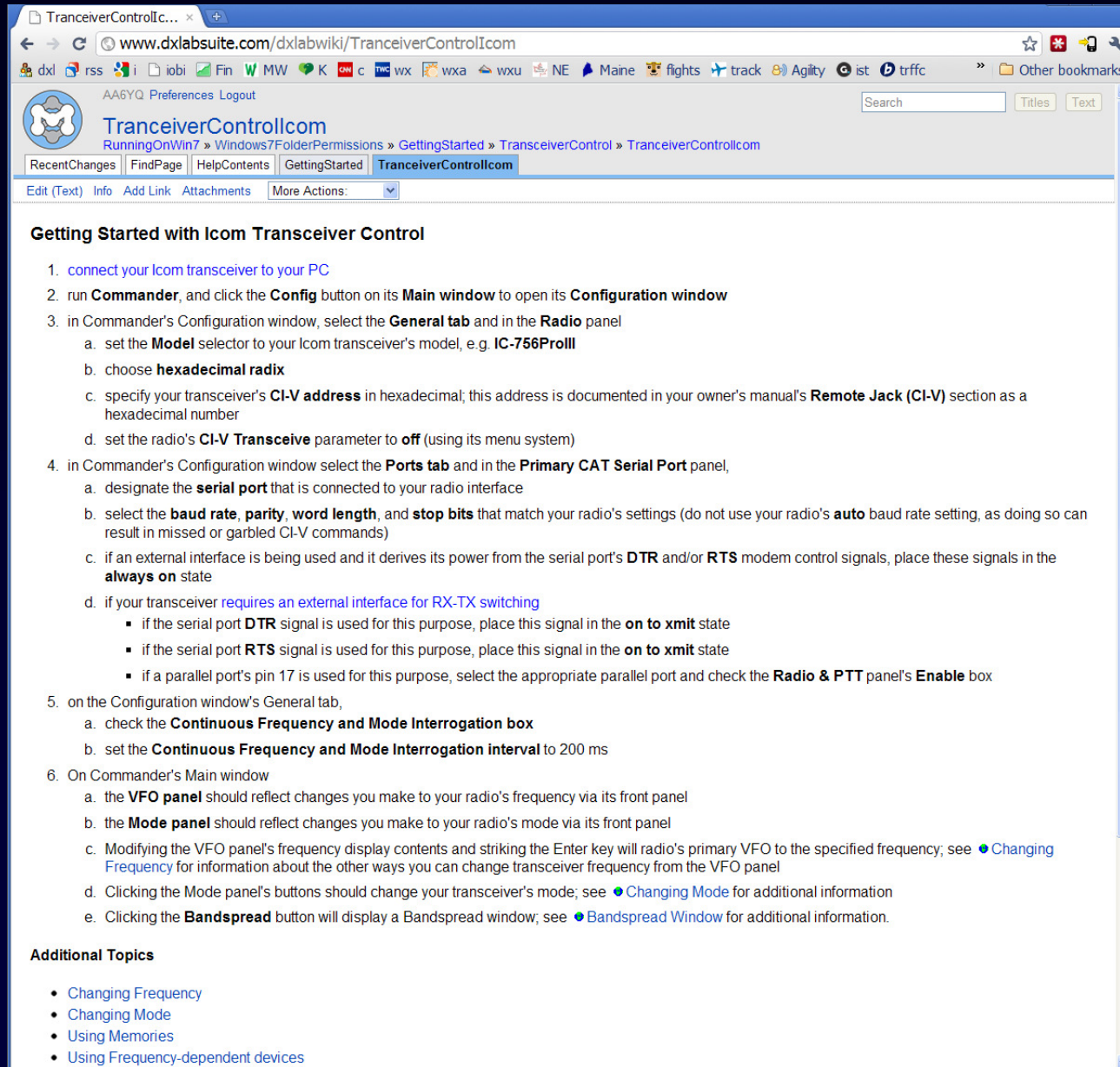

TranceiverControl.com

RunningOnWin7 » Windows7FolderPermissions » GettingStarted » TransceiverControl » TranceiverControl.com

Getting Started with Icom Transceiver Control

1. [connect your Icom transceiver to your PC](#)
2. run **Commander**, and click the **Config** button on its **Main window** to open its **Configuration window**
3. in Commander's Configuration window, select the **General tab** and in the **Radio** panel
 - a. set the **Model** selector to your Icom transceiver's model, e.g. **IC-756ProIII**
 - b. choose **hexadecimal radix**
 - c. specify your transceiver's **CI-V address** in hexadecimal; this address is documented in your owner's manual's **Remote Jack (CI-V)** section as a hexadecimal number
 - d. set the radio's **CI-V Transceive** parameter to **off** (using its menu system)
4. in Commander's Configuration window select the **Ports tab** and in the **Primary CAT Serial Port** panel,
 - a. designate the **serial port** that is connected to your radio interface
 - b. select the **baud rate**, **parity**, **word length**, and **stop bits** that match your radio's settings (do not use your radio's **auto** baud rate setting, as doing so can result in missed or garbled CI-V commands)
 - c. if an external interface is being used and it derives its power from the serial port's **DTR** and/or **RTS** modem control signals, place these signals in the **always on** state
 - d. if your transceiver [requires an external interface for RX-TX switching](#)
 - if the serial port **DTR** signal is used for this purpose, place this signal in the **on to xmit** state
 - if the serial port **RTS** signal is used for this purpose, place this signal in the **on to xmit** state
 - if a parallel port's pin 17 is used for this purpose, select the appropriate parallel port and check the **Radio & PTT** panel's **Enable** box
5. on the Configuration window's General tab,
 - a. check the **Continuous Frequency and Mode Interrogation box**
 - b. set the **Continuous Frequency and Mode Interrogation interval** to 200 ms
6. On Commander's Main window
 - a. the **VFO panel** should reflect changes you make to your radio's frequency via its front panel
 - b. the **Mode panel** should reflect changes you make to your radio's mode via its front panel
 - c. Modifying the VFO panel's frequency display contents and striking the Enter key will radio's primary VFO to the specified frequency; see [Changing Frequency](#) for information about the other ways you can change transceiver frequency from the VFO panel
 - d. Clicking the Mode panel's buttons should change your transceiver's mode; see [Changing Mode](#) for additional information
 - e. Clicking the **Bandspread** button will display a Bandspread window; see [Bandspread Window](#) for additional information.

Additional Topics

- [Changing Frequency](#)
- [Changing Mode](#)
- [Using Memories](#)
- [Using Frequency-dependent devices](#)

Documentation: Explanatory Popups

Radio

IC-756PROIII Model

76 CI-V Address Default: 6E 16

Hexadecimal Decimal

Reset

Continuous interrogation

50 Command interval (ms)

60 Scan dwell

Display Error Log

Synchronize transceiver frequencies before logging or spotting

the time interval between command groups sent to the transceiver, in milliseconds

the DXLab Suite

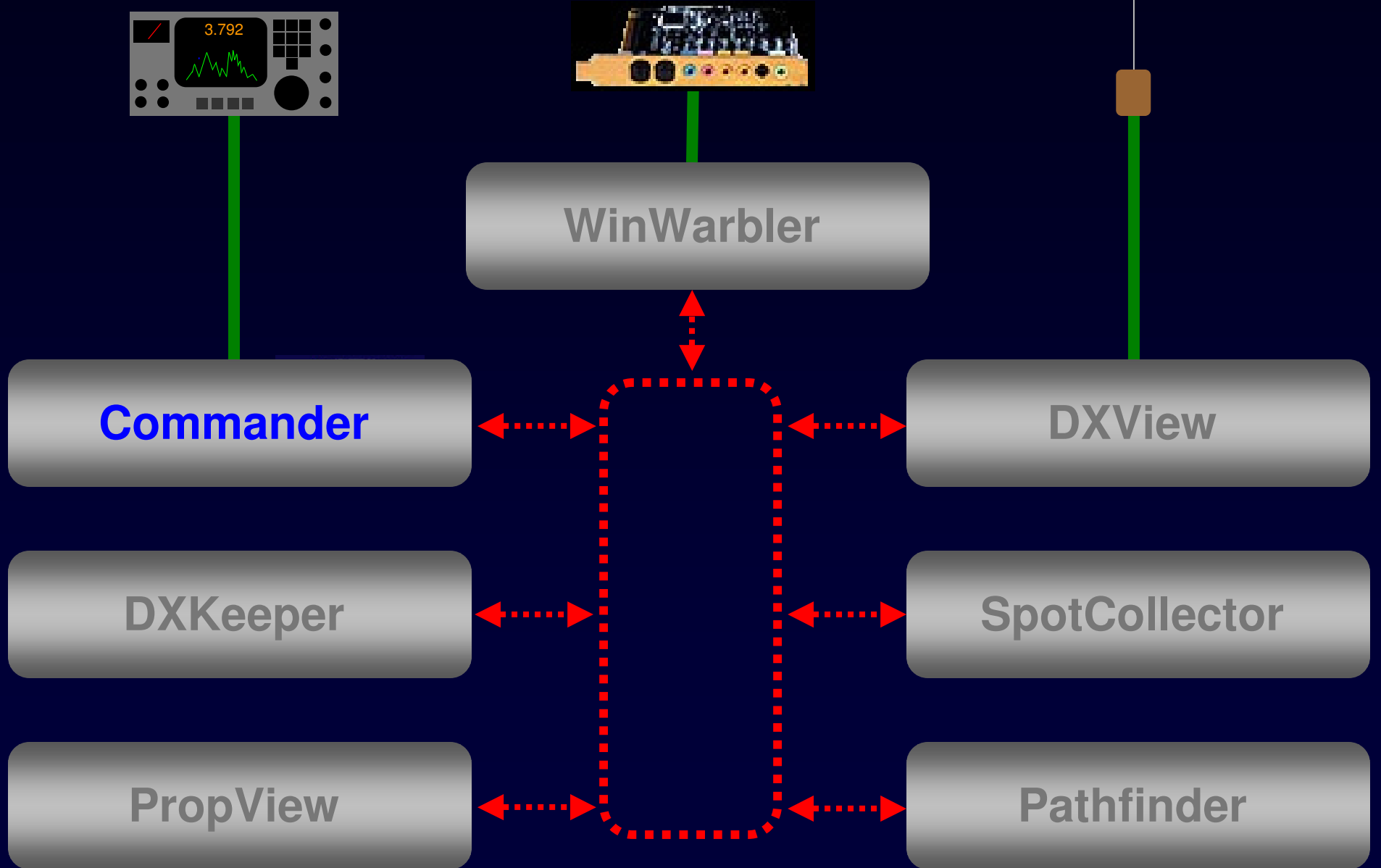

Commander: Transceiver Control

- Controls and displays
 - Frequency & Mode
 - Receiver bandwidth
 - Split & Dual Receive
 - Other CAT-accessible settings via user-defined controls
 - Transverters on 6m, 4m, 2m, 70cm
- Manages frequency-dependent devices
 - Displays settings for Tuners and Amplifiers
 - Supports automatic Antenna and Transceiver switching
- Switches among 4 primary radios
- Secondary CAT Port
 - Frequency and mode tracking by an independent radio
 - SDR-based panadaptors (SpectraVue, CW Skimmer, BobCAT)

Commander: Transceiver Control

Commander 8.5.8 [Icom IC-7800] @ 03:50:45 Z 14,016.00 CW Split

Sub VFO (TX): 20M **S0**
14,016.00
0 999
Main Sub M = S M x S XFC
IC-7800
 Split Mark V
 Dual receive TS-2000
 Ham bands only FT-817

Main VFO
14,015.00

Filters
Group
Width 20
PBT 1 50
PBT 2 50

PTT
TX RX

AL-1200
Plate 7.75 Load 3.5 Band 20

Mode: CW
 LSB (normal) FM (wide)
 USB (normal) AM (wide)
 CW (narrow) RTTY (wide)
 CW-R (narrow) RTTY-R (wide)

ATR-30
Xmit 9 Ant 7 L 75

Bandspread Msgs Scan Memory Banks Config Help

User-defined Controls
F5 Ant 1 F6 Tune F7 QRP F8 Data ALT F9 NR F10 NB F11 MNF F12 TPF
RF Gain 100% AF Gain 34% RF Pwr 100 w Keyer 33 wpm

Commander: Transceiver Control

- Controls and displays
 - Frequency & Mode
 - Receiver bandwidth
 - Split & Dual Receive
 - Other CAT-accessible settings (standard and user-defined controls)
 - Transverters on 6m, 4m, 2m, 70cm
- Manages frequency-dependent devices
 - Displays settings for Tuners and Amplifiers
 - Supports automatic Antenna and Transceiver switching
- Switches among 4 primary radios
- Secondary CAT Port
 - Frequency and mode tracking by an independent radio
 - SDR-based panadaptors (SpectraVue, CW Skimmer, BobCAT)

Commander: Multiple Radio Support

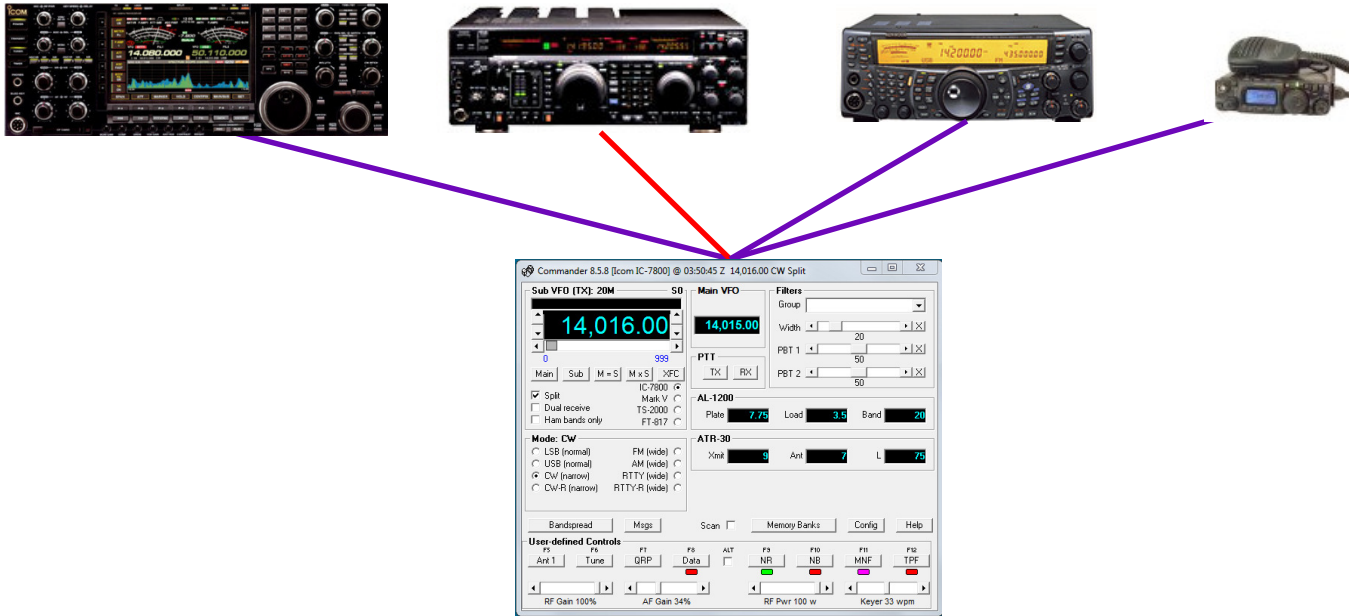

Select one of four *primary* radios

- By button click
- Automatically as a function of frequency

Commander: Multiple Radio Support

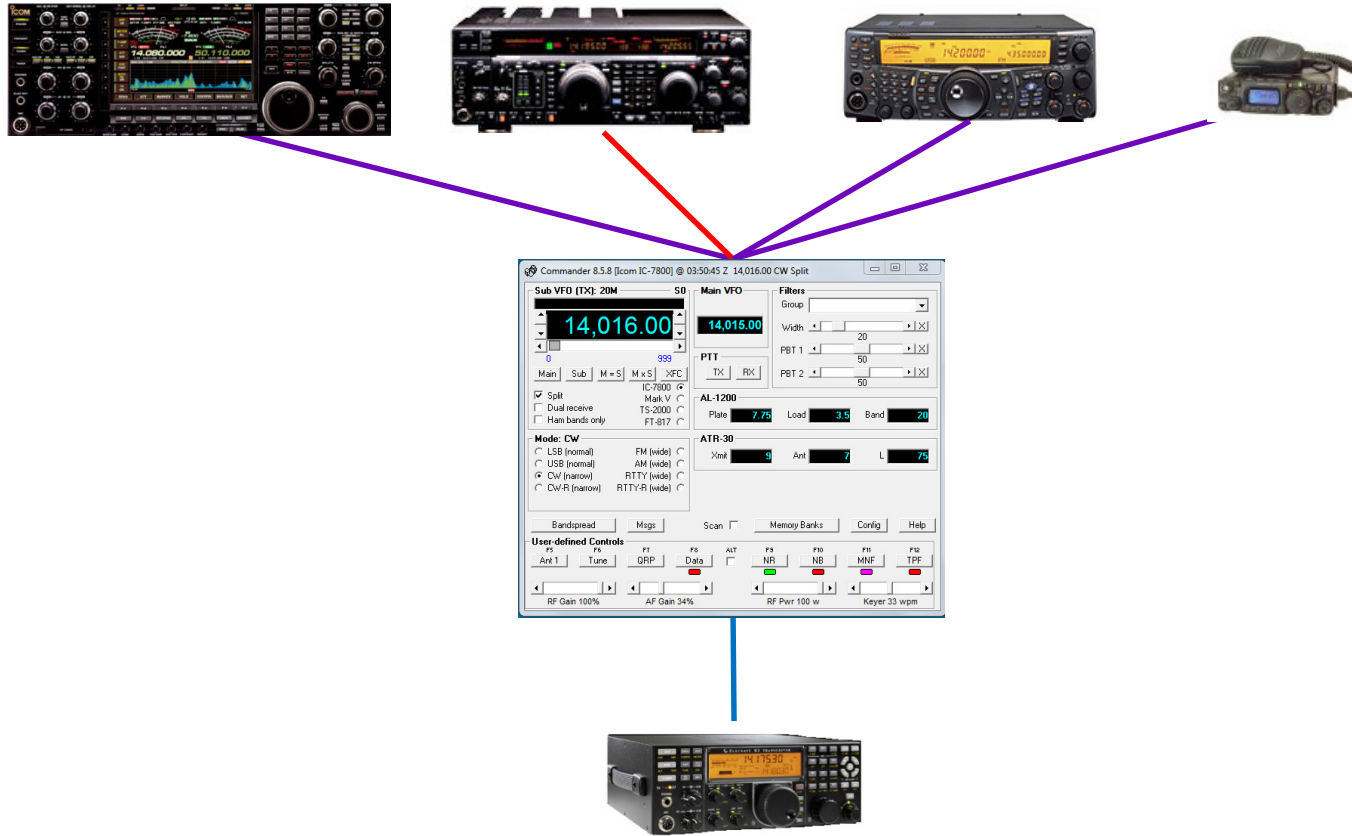

The *Secondary* radio can

- Follow the active primary radio
- Lead the active primary radio

Commander: Multiple Radio Support

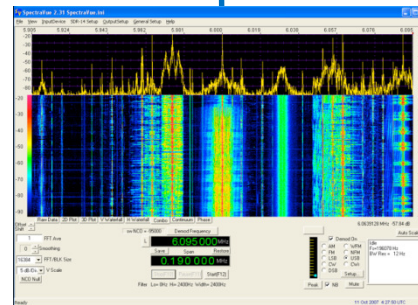
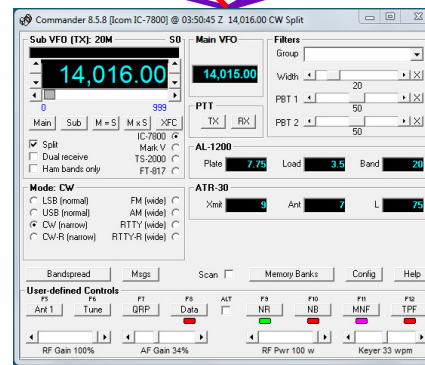

- The *Secondary* radio can
- Follow the active primary radio
 - Lead the active primary radio

Commander Memories: 10 Banks of 10

Commander 8.5.8 [Icom IC-7200] @ 20:22:06 Z 14,015.00 CW Split

VFO B (TX): 20M 1
14,015.00
0 999
A B A=B A x B XFC
IC-7200
 Split
 Ham bands only

Mode: CW
 LSB (normal) FM (wide)
 USB (normal) AM (wide)
 CW (narrow) RTTY (wide)
 CW-R (narrow) RTTY-R (wide)

Memory Bank 1

B1	B2	B3	B4	B5	B6	B7	B8	B9	B10
Sel	Frequency	Mode	Filter Group	Save					
1	1,825.00	CW	normal	1					
2	3,505.00	CW	normal	2					
3	3,750.00	LSB	narrow	3					
4	7,005.00	CW	wide	4					
5	10,105.00	CW	wide	5					
6	14,005.00	CW	wide	6					
7	18,070.00	CW	wide	7					
8	21,005.00	CW	wide	8					
9	24,890.00	CW	wide	9					
10	28,005.00	CW	wide	10					

Bandspread Msgs Scan Filters & Devices Config Help

User-defined Controls

F5	F6	F7	F8	ALT	F9	F10	F11	F12
Ant 1	Tune	QRP	Data	<input type="checkbox"/>	NR	NB	MNF	TPF
			<input checked="" type="checkbox"/>		<input checked="" type="checkbox"/>	<input checked="" type="checkbox"/>	<input checked="" type="checkbox"/>	<input checked="" type="checkbox"/>
RF Gain 100%	AF Gain 34%				RF Pwr 100 w		Keyer 33 wpm	

Commander Memories: Scanning

Commander 8.5.8 [Icom IC-7800] @ 03:54:42 Z 50,110.00 USB

Main VFO: 6M **S0**

50,110.00

0 999

Main Sub M = S M x S XFC

Split IC-7800
 Dual receive Mark V
 Ham bands only TS-2000
FT-817

Mode: USB

LSB (normal) FM (wide)
 USB (normal) AM (wide)
 CW (narrow) RTTY (wide)
 CW-R (narrow) RTTY-R (wide)

Memory Bank 2

Sel	Frequency	Mode	Filter Group	Save
11	50,110.00	USB	normal	11
12	50,115.00	USB	normal	12
13	50,120.00	USB	normal	13
14	50,125.00	USB	normal	14
15	50,130.00	USB	normal	15
16	50,135.00	USB	normal	16
17	50,140.00	USB	normal	17
18	50,145.00	USB	normal	18
19	50,150.00	USB	normal	19
20	50,155.00	USB	normal	20

Bandspread Msgs **Scan** Filters & Devices Config Help

User-defined Controls

F5 Ant 1 F6 Tune F7 QRP F8 Data ALT F9 NR F10 NB F11 MNF F12 TPF

RF Gain 100% AF Gain 34% RF Pwr 100 w Keyer 33 wpm

Commander: Bandspread

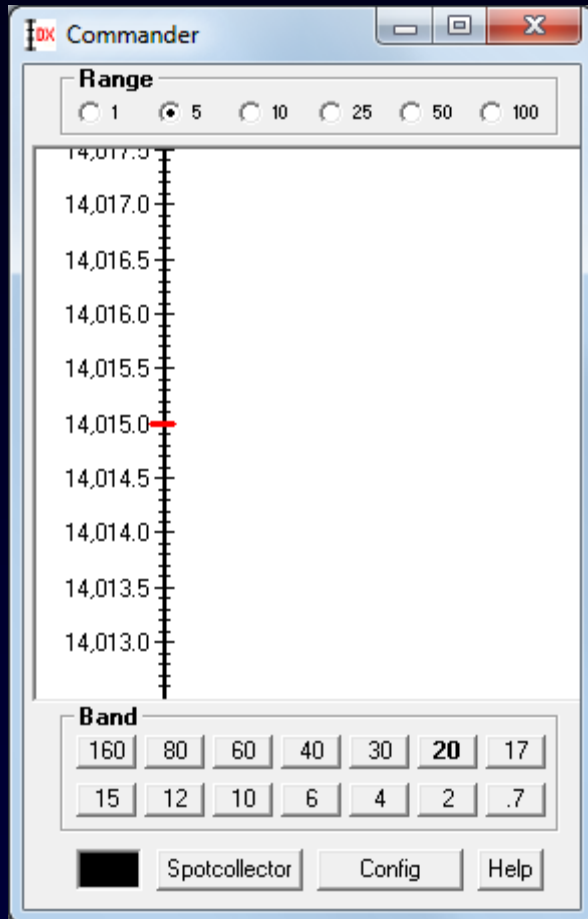

Commander: More Than 100 Radios Supported

Hardware

- Alinco
- Elecraft
- Icom
- JRC
- Kachina
- Kenwood
- TenTec
- Yaesu

SDR Consoles

- BobCAT
- CWSkimmer
- PowerSDR
- SpectraVue
- SDR-Radio

SDR

- FlexRadio
- HPSSDR Mercury
- Microtelecom Perseus
- RFSpace SDR-IQ, SDR-14
- SoftRock
- SRL QuickSilver QS1R

the DXLab Suite

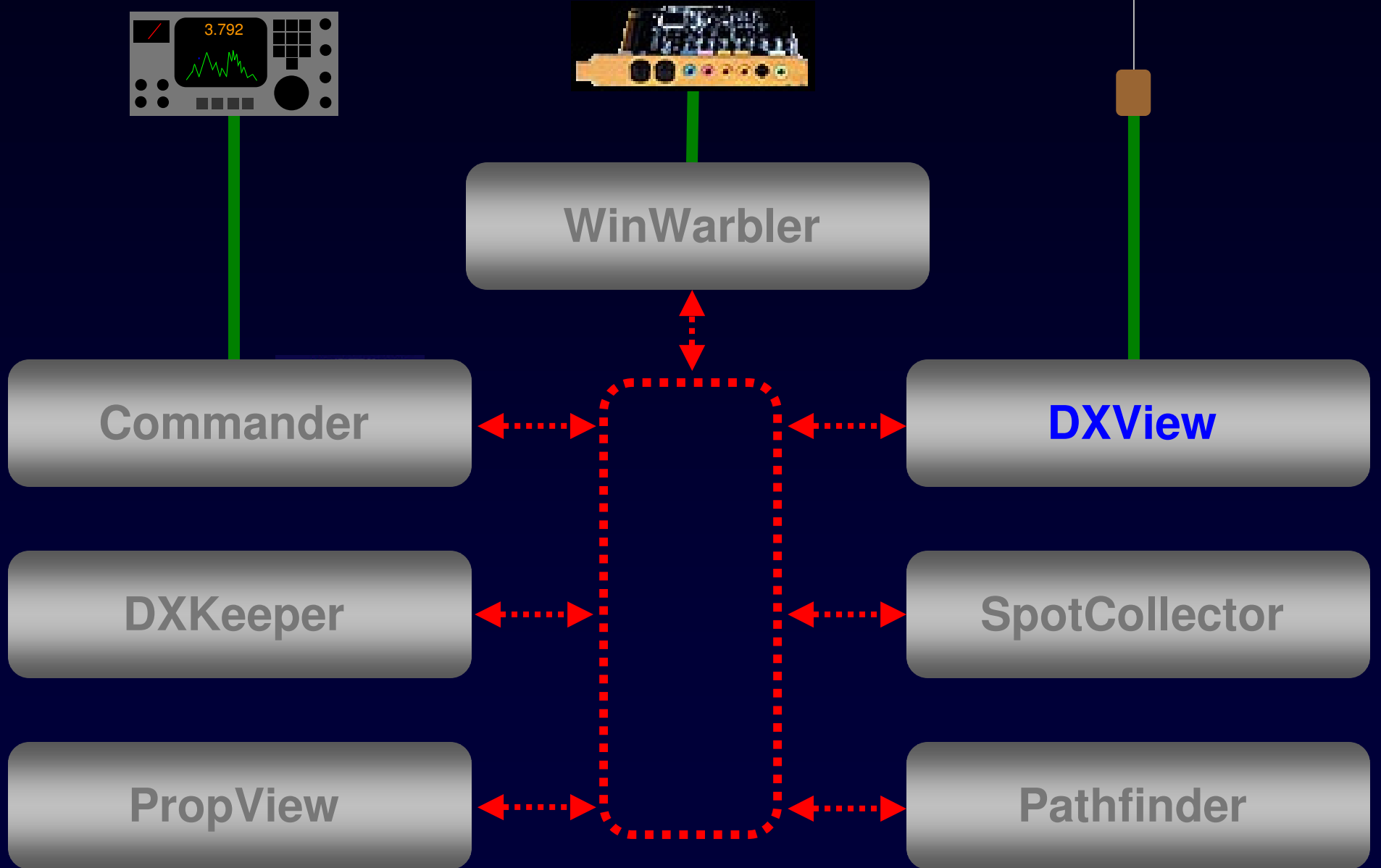

DXView Information

DXView Info 3.5.2 @ 2010-10-04 20:35:25 Z [SC]

Search **DXCC (last LotW upload: 2005-07-17)**

callsign prefix entity code

GeoMag max K

Antenna presets

Location @ 2010-10-05 02:05:25 local **DXCC database**

latitude longitude SP DX cont grid CQ ITU

location IOTA time zone

Heading short long

Special Callsign Tags

VU Progress (AA6YQ.mdb)

	160M	80M	40M	30M	20M	17M	15M	12M	10M	6M	2M
PHONE		V			R		V	V	V		
CW			V	C	V	V	W				
RTTY					V		R				
PSK					C						

Map

- by Callsign
- by Prefix
- by IOTA tag
- by Grid
- by Latitude/Longitude

DXView Information: Phrase Translation

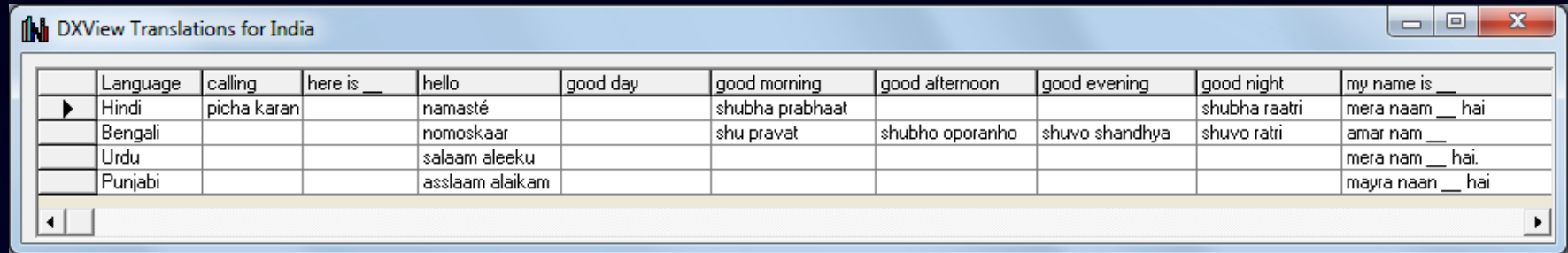

The screenshot shows a window titled "DXView Translations for India" with a table of phrase translations. The table has 11 columns: Language, calling, here is __, hello, good day, good morning, good afternoon, good evening, good night, and my name is __. The rows represent different languages: Hindi, Bengali, Urdu, and Punjabi. The table is scrollable, as indicated by the scrollbar on the right.

Language	calling	here is __	hello	good day	good morning	good afternoon	good evening	good night	my name is __
Hindi	picha karan		namasté		shubha prabhaat			shubha raatri	mera naam __ hai
Bengali			nomoskaar		shu pravat	shubho oporanho	shuvo shandhya	shuvo ratri	amar nam __
Urdu			salaam aleeku						mera nam __ hai.
Punjabi			asslaam alaikam						mayra naan __ hai

DXView Databases

DXView Configuration

General Plot Settings Rotator Control World Map Overrides **Databases**

Database Versions

Check for new versions on startup New?

Database	Installed	Available	Action
DXCC	2.3.1	2.3.1	Upgrade
IOTA	1.1.5	1.1.5	Upgrade
USAP	2010-06-29	2010-06-29	Upgrade
LotW	2010-09-11	2010-09-25	Upgrade
eQSL AG	2010-09-25	2010-09-25	Upgrade
Translation	1.0.6	1.0.6	Upgrade

Help

DXView Information: USAP Database

DXView Info 3.5.2 @ 2010-10-04 20:50:32 Z [PF,SC]

Search **DXCC (last LotW upload: 2010-10-02)** **GeoMag** **Antenna presets**

callsign prefix entity code max K

Location @ 2010-10-04 15:50:32 local **USAP database** **Heading**

latitude longitude SP DX cont grid CQ ITU short long

location IOTA time zone

Special Callsign Tags

K Progress (AA6YQ.mdb)

	160M	80M	40M	30M	20M	17M	15M	12M	10M	6M	2M
PHONE	V	C	V		V	V	V	W	V	V	W
CW	C	C	V	V	V	V	V	V	C	V	C
RTTY	C	V	V	C	C	W	V		C	W	
PSK	C	C	C	C	C	W	C			W	

Map

Antenna presets: 0, 45, 90, 135, 180, 225, 270, 315, Bonaire, Saba, Marion Is

- by Callsign
- by Prefix
- by IOTA tag
- by Grid
- by Latitude/Longitude

DXView Rotator Control

DXView Info 3.5.2 @ 2010-10-04 20:35:25 Z [SC]

Search DXCC (last LotW upload: 2005-07-17)

callsign prefix entity code

GeoMag max K

Location @ 2010-10-05 02:05:25 local DXCC database

latitude longitude SP DX cont grid CQ ITU

location IOTA time zone

Heading short long

Special Callsign Tags

VU Progress [AA6YQ.mdb]

	160M	80M	40M	30M	20M	17M	15M	12M	10M	6M	2M
PHONE		V			R		V	V	V		
CW			V	C	V	V	W				
RTTY					V		R				
PSK					C						

Map

Antenna presets

-
-
-
-
-
-
-
-
-
-
-

- AlfaSpid
- ARSWIN
- Heath
- Hygain
- LP-Rotor
- M2
- N1MM
- Prosistel
- SARtek
- TIC
- TrackBox
- Yaesu

DXView: World Map Display

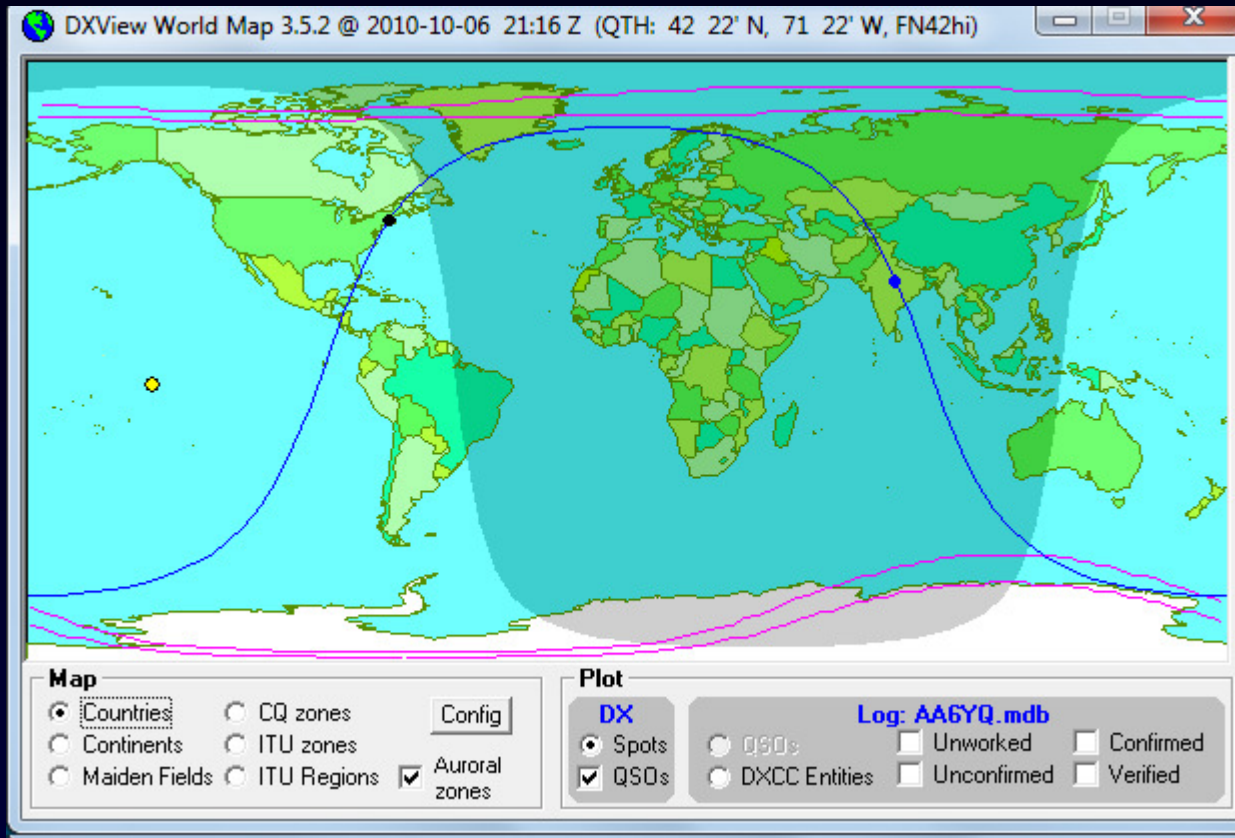

- Beam heading
- Solar terminator
- Auroral Zone Boundaries
- Point & Click
 - Antenna Rotation
 - Propagation Prediction

DXView: CQ Zone Overlay

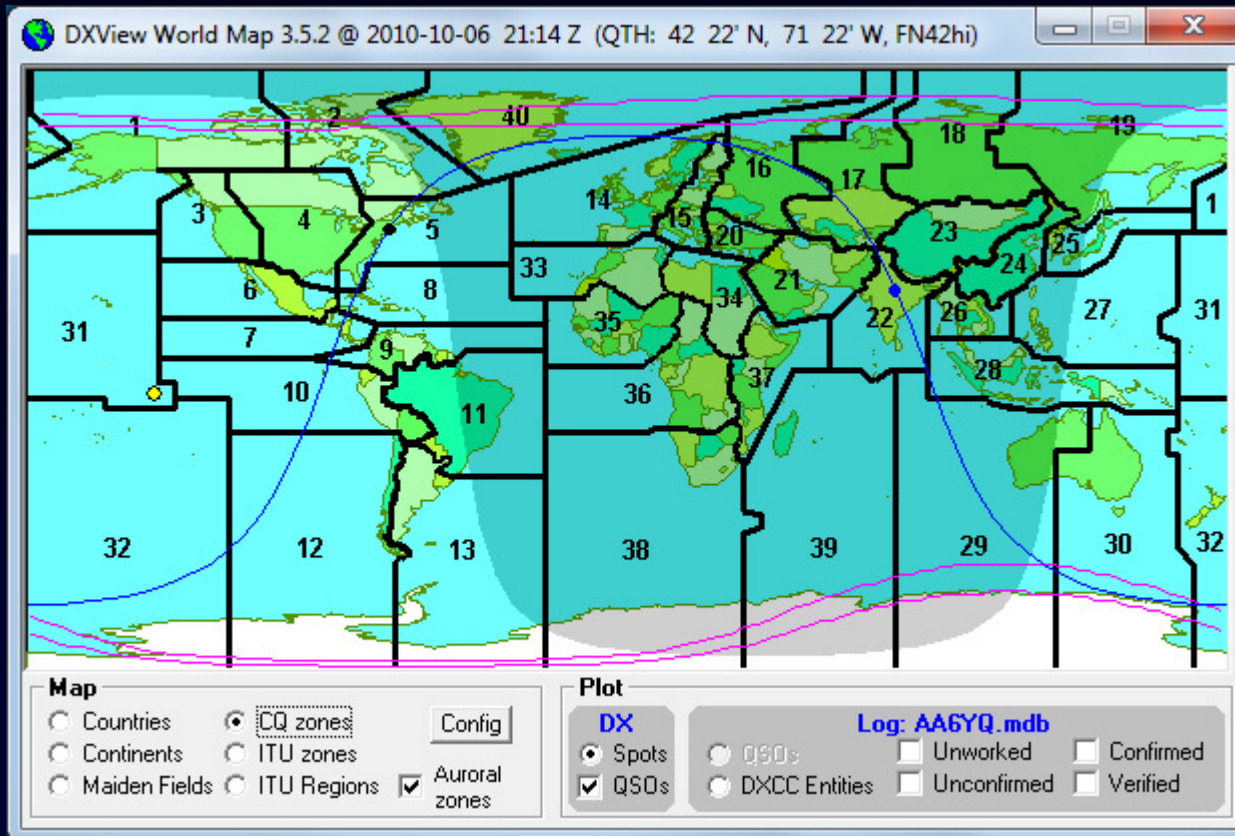

- Beam heading
- Solar terminator
- Auroral Zone Boundaries

- Point & Click
 - Antenna Rotation
 - Propagation Prediction

DXView: ITU Zone Overlay

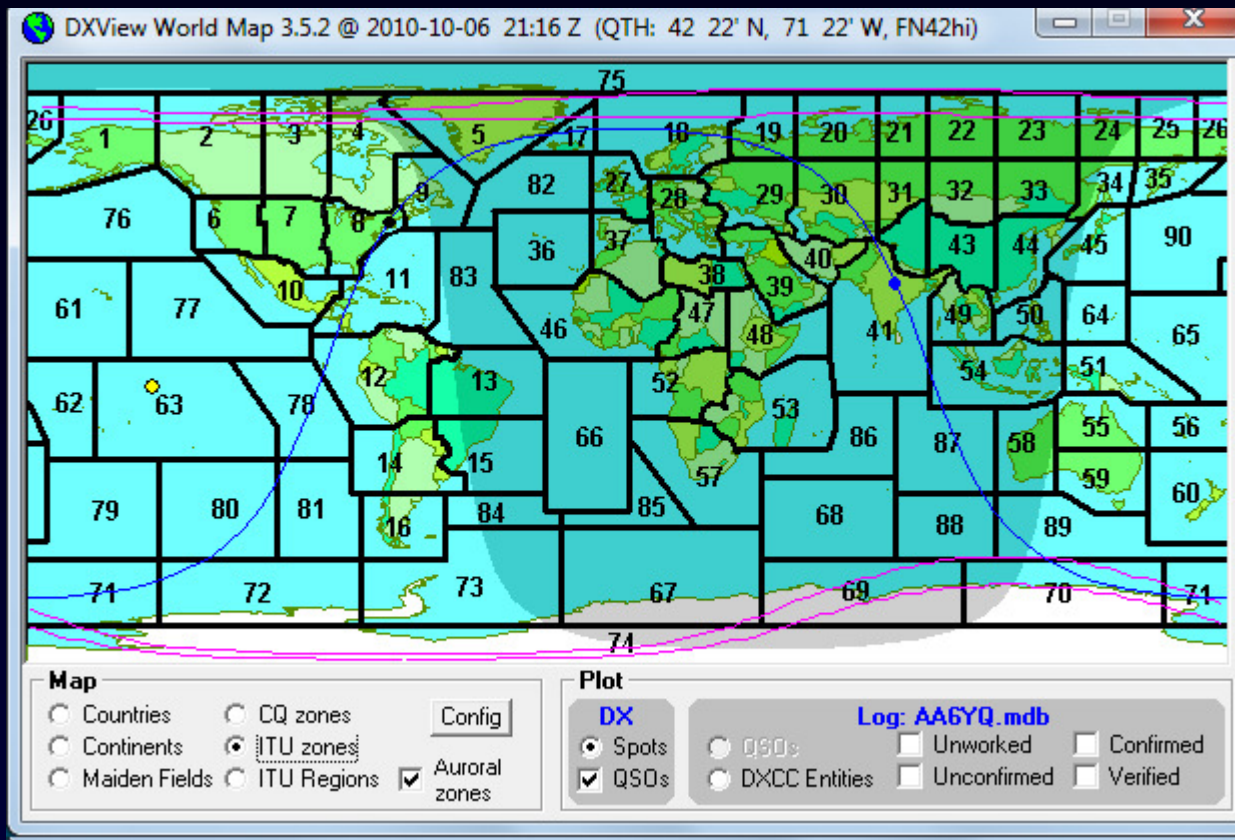

- Beam heading
- Solar terminator
- Auroral Zone Boundaries
- Point & Click
 - Antenna Rotation
 - Propagation Prediction

DXView: Maidenhead Field Overlay

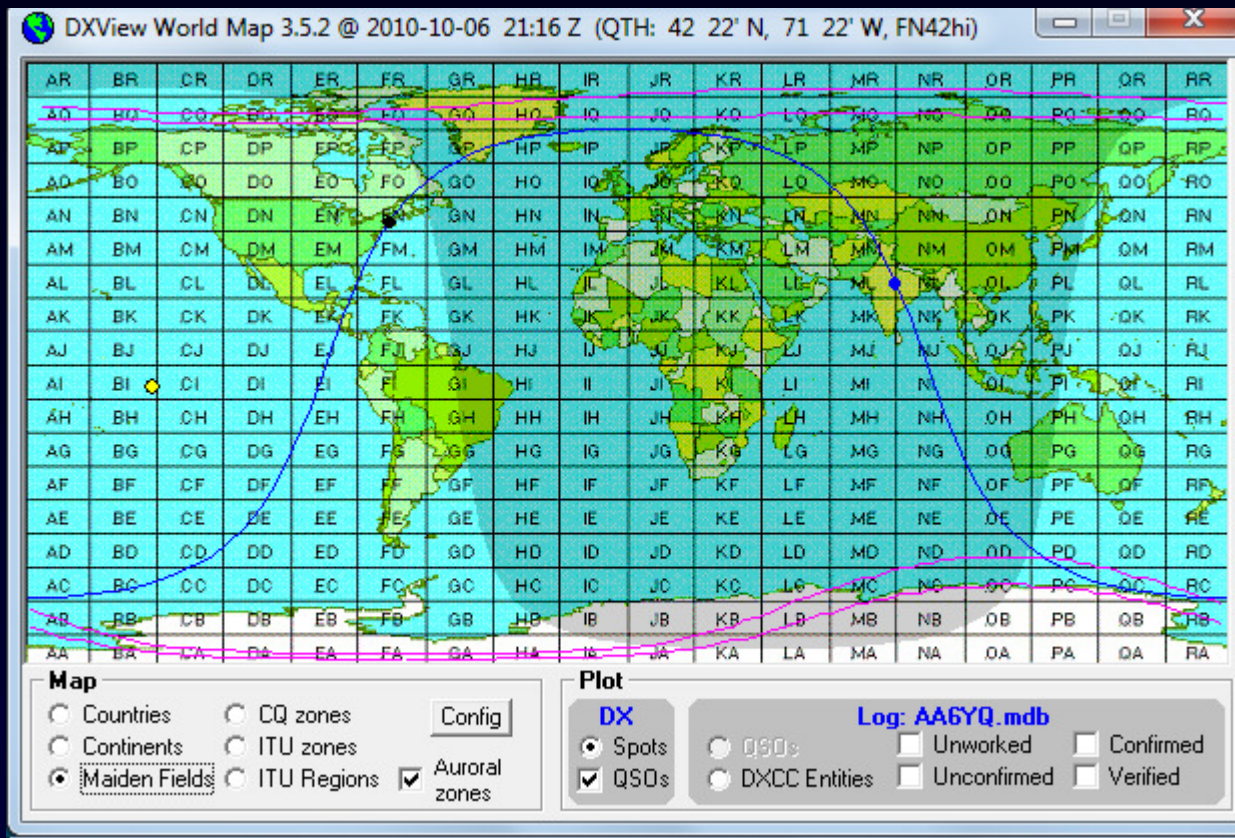

- Beam heading
- Solar terminator
- Auroral Zone Boundaries
- Point & Click
 - Antenna Rotation
 - Propagation Prediction

DXView: Solar Terminator

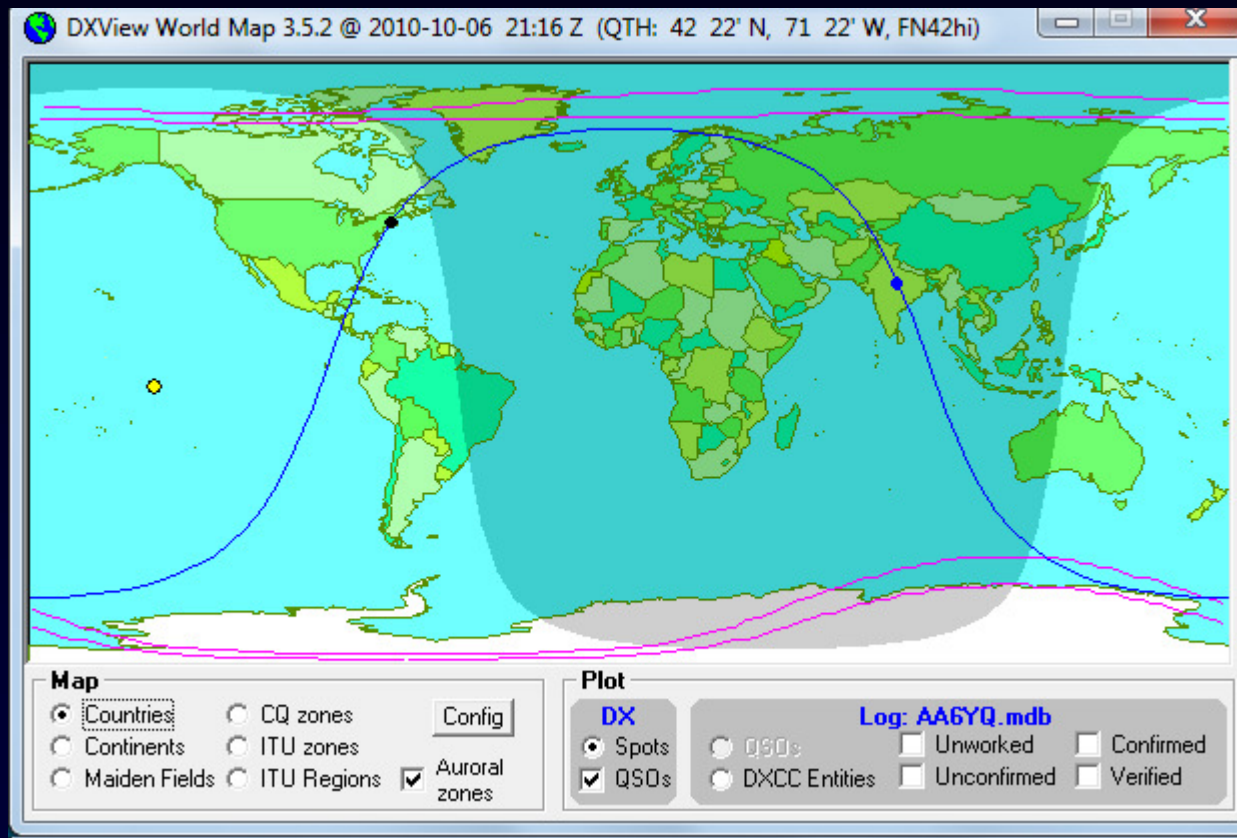

DXView Sunrise/Sunset Times

DXView Sunrise/Sunset @ 20:42:56 Z

DX

Latitude Longitude UTC Date

Date	QTH Sunrise	QTH Sunset	DX Sunrise	DX Sunset
Oct 4	10:43	22:21	00:31	12:23
Oct 5	10:44	22:20	00:31	12:22
Oct 6	10:45	22:18	00:31	12:21
Oct 7	10:46	22:16	00:32	12:20
Oct 8	10:48	22:15	00:32	12:19
Oct 9	10:49	22:13	00:33	12:18
Oct 10	10:50	22:11	00:33	12:17
Oct 11	10:51	22:10	00:34	12:16
Oct 12	10:52	22:08	00:34	12:15
Oct 13	10:54	22:06	00:35	12:14
Oct 14	10:55	22:05	00:35	12:14
Oct 15	10:56	22:03	00:36	12:13
Oct 16	10:57	22:02	00:36	12:12
Oct 17	10:58	22:00	00:37	12:11
Oct 18	11:00	21:59	00:37	12:10
Oct 19	11:01	21:57	00:38	12:10
Oct 20	11:02	21:56	00:38	12:09
Oct 21	11:03	21:54	00:39	12:08
Oct 22	11:05	21:53	00:39	12:07
Oct 23	11:06	21:51	00:40	12:07
Oct 24	11:07	21:50	00:40	12:06
Oct 25	11:09	21:49	00:41	12:05
Oct 26	11:10	21:47	00:42	12:04
Oct 27	11:11	21:46	00:42	12:04
Oct 28	11:12	21:45	00:43	12:03
Oct 29	11:14	21:43	00:43	12:03
Oct 30	11:15	21:42	00:44	12:02
Oct 31	11:16	21:41	00:45	12:01
Nov 1	11:18	21:39	00:45	12:01
Nov 2	11:19	21:38	00:46	12:00
Nov 3	11:20	21:37	00:47	12:00

DXView: Country Maps

DXView Info 3.5.2 @ 2010-10-04 20:35:25 Z [SC]

Search **DXCC (last LotW upload: 2005-07-17)**

callsign prefix entity code

GeoMag max K

Antenna presets

Location @ 2010-10-05 02:05:25 local **DXCC database**

latitude longitude SP DX cont grid CQ ITU

location IOTA time zone

Heading short long

Special Callsign Tags

VU Progress (AA6YQ.mdb)

	160M	80M	40M	30M	20M	17M	15M	12M	10M	6M	2M
PHONE		V			R		V	V	V		
CW			V	C	V	V	W				
RTTY					V		R				
PSK					C						

Map

Antenna presets: 0, 45, 90, 135, 180, 225, 270, 315, Bonaire, Saba, Marion Is

DXView: Country Maps



DXView: Google Maps

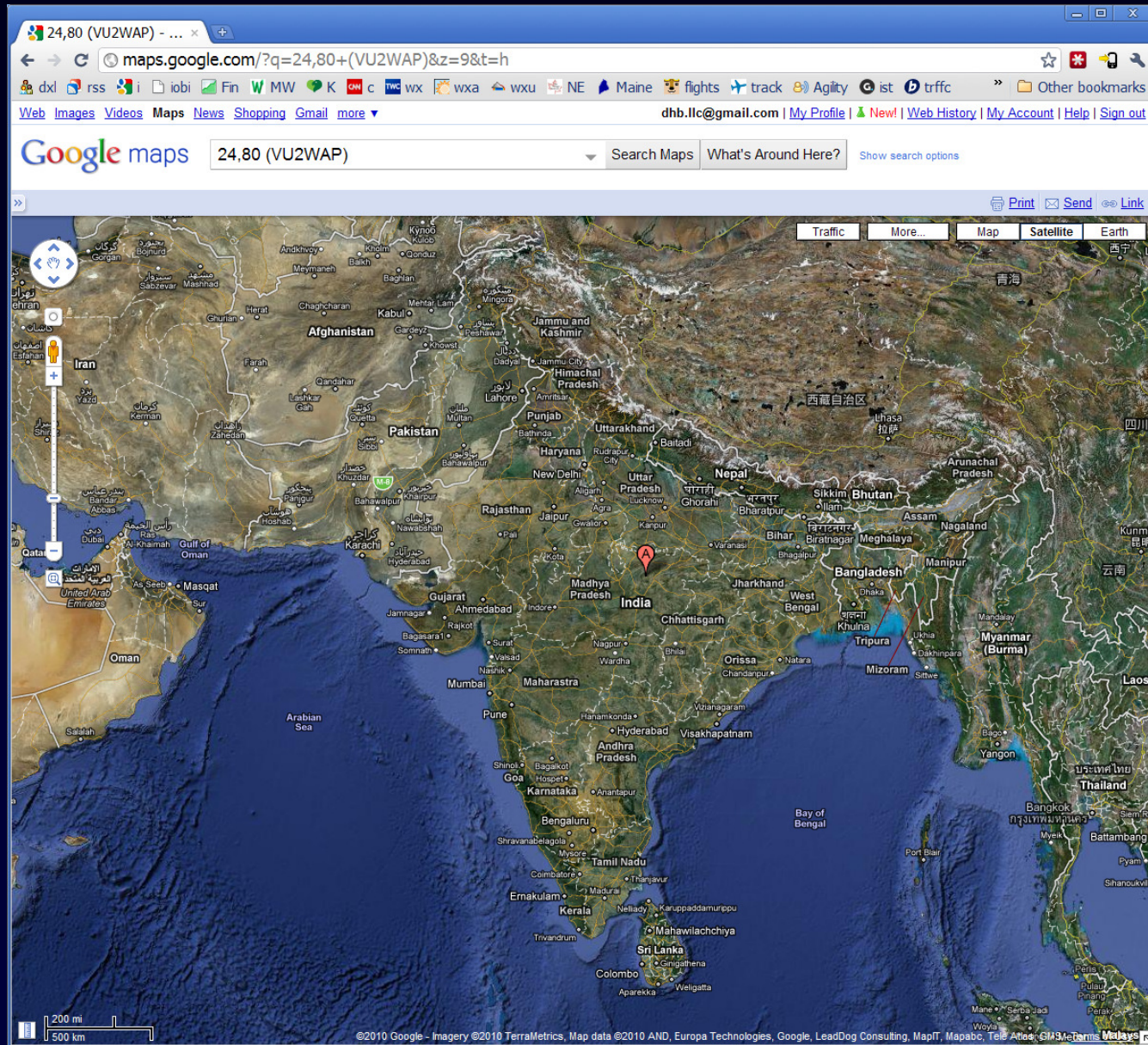

the DXLab Suite

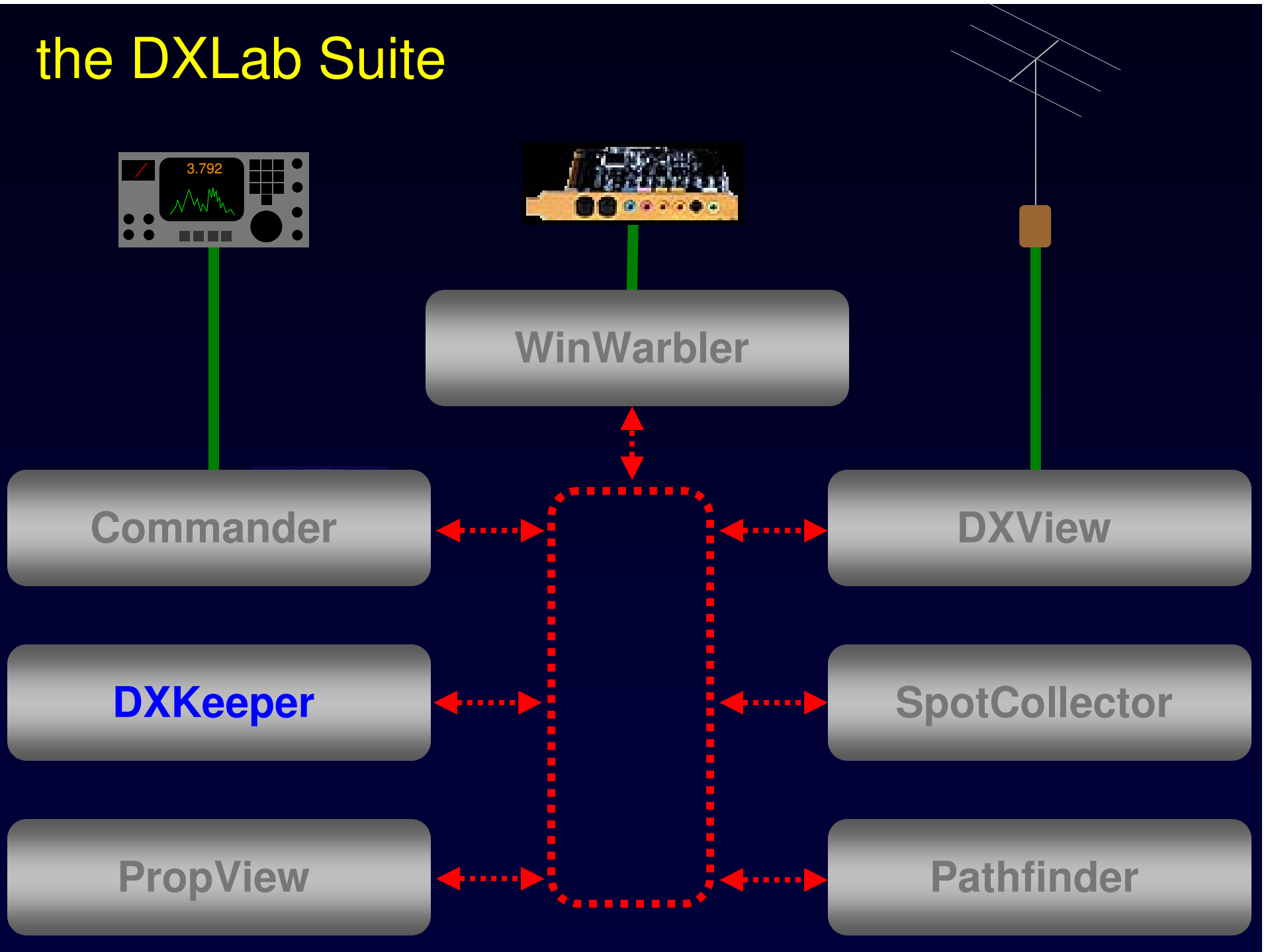

DXKeeper

- Logging
- QSLing
- Award Tracking
- Multiple QTHs per log
- Import QSOs from file
- Export QSOs to file

DXKeeper

- Logging
- QSLing
- Award Tracking
- Multiple QTHs per log
- Import QSOs from file
- Export QSOs to file

DXKeeper 8.9.4 [CC,DXV,PV,WW] - AA6YQ.mdb : 18487 QSOs

Log QSOs | QSL | Check Progress | my QTHs | Import QSOs | Export QSOs

QSO: Jordan (00:15)

call: JY4NE | name: Ali | QTH: Aman

mode: RTTY | via: | tx freq: 14.087 | begin: 9/20/2010 18:37

sent: 599 | rcvd: 599 | tx band: 20M | rx freq: 14.086 | end: 9/20/2010 18:38

power: 1500 | code: 342 | DXCC: JY | entity: Jordan

Auxiliary
 QSL
 Online QSL
 Award
 Contest
 Propagation
 Details
 User-defined

New | Save | Undo | CBA | Delete | Report | Plot | 18487 | Adv | RAT | Capture | Config | Help

Call	Name	DXCC	Starting UTC	Mode	Freq	RX Freq	Band	Sent	Rcvd	QTH
IK5UAN	Roberto	I	9/19/2010 10:47	RTTY	14.087	14.087	20M	599	599	Monsummano Ter. Pt
HA5VZ	Miklos	HA	9/19/2010 10:51	RTTY	14.086	14.086	20M	599	599	Budapest
UX2SB	Vasil	UT	9/19/2010 10:52	RTTY	14.086	14.086	20M	599	599	Ivano-fr. Obl.
G3WCY	Brian	G	9/19/2010 10:53	RTTY	14.086	14.086	20M	599	579	Near Oxford
OH2LZI	Heikki	OH	9/19/2010 10:55	RTTY	14.086	14.086	20M	559	599	Pernaja
DD8HB	Rolf	DL	9/19/2010 10:57	RTTY	14.086	14.086	20M	599	599	Luebeck-schlutup
JH8JYV	Hide	JA	9/19/2010 21:43	CW	18.075	18.075	17M	599	599	Sapporo-city
PJ7N9NA	John	PJ5	9/19/2010 21:59	CW	18.075	18.075	17M	559	589	
JT5DX	Chadraabal	JT	9/19/2010 23:23	CW	18.075	18.075	17M	599	599	Mongolia
RX0AT	Vit	UA	9/20/2010 01:01	RTTY	14.082	14.082	20M	599	599	Krasnoyarsk
KP4JFR	Jose	KP4	9/20/2010 01:11	RTTY	14.083	14.083	20M	599	599	Trujillo Alto, PR
JY4NE	Ali	JY	9/20/2010 18:37	RTTY	14.087	14.086	20M	599	599	Aman

Sort: UTC Call Adv | Filter: None

X | Call | DXCC | Date | Since | Sel | LotW | Broke | ~

DXKeeper: Logging

- Comprehensive log database
- Powerful QSO searching, sorting, and editing
- Capture window optimized for operating
- Callbook access

DXKeeper Main Window

DXKeeper 8.9.4 [CC,DXV,PV,WW] - AA6YQ.mdb : 18487 QSOs

Log QSOs QSL Check Progress my QTHs Import QSOs Export QSOs

QSO: Jordan (00:15)

call JY4NE name Ali QTH Amman

mode RTTY via tx freq 14.087 begin 9/20/2010 18:37

sent 599 rcvd 599 tx band 20M rx freq 14.086 end 9/20/2010 18:38

power 1500 code 342 DXCC JY entity Jordan

Auxiliary
 QSL
 Online QSL
 Award
 Contest
 Propagation
 Details
 User-defined

New Save Undo CBA Delete Report Plot 18487 Adv RAT Capture Config Help

Call	Name	DXCC	Starting UTC	Mode	Freq	RX Freq	Band	Sent	Rcvd	QTH
IK5UAN	Roberto	I	9/19/2010 10:47	RTTY	14.087	14.087	20M	599	599	Monsummano Ter. Pt
HA5VZ	Miklos	HA	9/19/2010 10:51	RTTY	14.086	14.086	20M	599	599	Budapest
UX2SB	Vasil	UT	9/19/2010 10:52	RTTY	14.086	14.086	20M	599	599	Ivano-fr. Obl.
G3W/CY	Brian	G	9/19/2010 10:53	RTTY	14.086	14.086	20M	599	579	Near Oxford
OH2LZI	Heikki	OH	9/19/2010 10:55	RTTY	14.086	14.086	20M	559	599	Pernaja
DD8HB	Rolf	DL	9/19/2010 10:57	RTTY	14.086	14.086	20M	599	599	Luebeck-schlutup
JH8JYV	Hide	JA	9/19/2010 21:43	Cw	18.075	18.075	17M	599	599	Sapporo-city
PJ7/N9NA	John	PJ5	9/19/2010 21:59	Cw	18.075	18.075	17M	559	589	
JT5DX	Chadraabal	JT	9/19/2010 23:23	Cw	18.075	18.075	17M	599	599	Mongolia
RX0AT	Vit	UA0	9/20/2010 01:01	RTTY	14.082	14.082	20M	599	599	Krasnoyarsk
KP4JFR	Jose	KP4	9/20/2010 01:11	RTTY	14.083	14.083	20M	599	599	Trujillo Alto, PR
JY4NE	Ali	JY	9/20/2010 18:37	RTTY	14.087	14.086	20M	599	599	Amman

Sort Filter: None

UTC Call Adv

X Call DXCC Date Since Sel LotW Broke ~

DXKeeper Main Window: Previous QSOs

DXKeeper 8.9.4 [CC,DXV,PV,WW] - AA6YQ.mdb (filtered): 5 QSOs

Log QSOs QSL Check Progress my QTHs Import QSOs Export QSOs

QSO: Jordan (00:15)

call JY4NE name Ali QTH Amman

mode RTTY via tx freq 14.087 begin 9/20/2010 18:37

sent 599 rcvd 599 tx band 20M rx freq 14.086 end 9/20/2010 18:38

power 1500 code 342 DXCC JY entity Jordan

Auxiliary
 QSL
 Online QSL
 Award
 Contest
 Propagation
 Details
 User-defined

New Save Undo CBA Delete Report Plot 5 Adv RAT Capture Config Help

	Call	Name	DXCC	Starting UTC		Mode	Freq	RX Freq	Band	Sent	Rcvd	QTH
	JY4NE	Ali	JY	9/5/1999	03:17	SSB	14.292		20M	59	59	
	JY4NE	Ali	JY	9/5/1999	17:08	SSB	28.470		10M	33	55	
	JY4NE	Ali	JY	9/13/2003	18:45	RTTY	14.083		20M	599	599	
	JY4NE	Ali	JY	7/19/2010	03:50	CW	14.037	14.037	20M	599	599	Amman
▶	JY4NE	Ali	JY	9/20/2010	18:37	RTTY	14.087	14.086	20M	599	599	Amman

Sort Filter: Previous QSOs with JY4NE

UTC Call Adv

JY4NE X Call DXCC Date Since Sel LotW Broke ~

DXKeeper Main Window: Award Panel

DXKeeper 8.9.4 [CC,DXV,PV,WW] - AA6YQ.mdb : 18487 QSOs

Log QSOs QSL Check Progress my QTHs Import QSOs Export QSOs

QSO: Jordan (00:15)

call JY4NE name Ali QTH Aman

mode RTTY via tx freq 14.087 begin 9/20/2010 18:37

sent 599 rcvd 599 tx band 20M rx freq 14.086 end 9/20/2010 18:38

power 1500 code 342 DXCC JY entity Jordan

Auxiliary
 QSL
 Online QSL
 Award
 Contest
 Propagation
 Details
 User-defined

Award

grid IOTA cont AS WPX JY4 CQ 20 ITU 39

pri sub ? sec sub ?

New Save Undo CBA Delete Report Plot 18487 Adv RAT Capture Config Help

Call	Name	DXCC	Starting UTC	Mode	Freq	RX Freq	Band	Sent	Rcvd	QTH
IK5UAN	Roberto	I	9/19/2010 10:47	RTTY	14.087	14.087	20M	599	599	Monsummano Ter. Pt
HA5VZ	Miklos	HA	9/19/2010 10:51	RTTY	14.086	14.086	20M	599	599	Budapest
UX2SB	Vasil	UT	9/19/2010 10:52	RTTY	14.086	14.086	20M	599	599	Ivano-fr. Obl.
G3WCY	Brian	G	9/19/2010 10:53	RTTY	14.086	14.086	20M	599	579	Near Oxford
OH2LZI	Heikki	OH	9/19/2010 10:55	RTTY	14.086	14.086	20M	559	599	Pernaja
DD8HB	Rolf	DL	9/19/2010 10:57	RTTY	14.086	14.086	20M	599	599	Luebeck-schlutup
JH8JYV	Hide	JA	9/19/2010 21:43	CW	18.075	18.075	17M	599	599	Sapporo-city
PJ7/N9NA	John	PJ5	9/19/2010 21:59	CW	18.075	18.075	17M	559	589	
JT5DX	Chadraabal	JT	9/19/2010 23:23	CW	18.075	18.075	17M	599	599	Mongolia
RX0AT	Vit	UA	9/20/2010 01:01	RTTY	14.082	14.082	20M	599	599	Krasnoyarsk
KP4JFR	Jose	KP4	9/20/2010 01:11	RTTY	14.083	14.083	20M	599	599	Trujillo Alto, PR
JY4NE	Ali	JY	9/20/2010 18:37	RTTY	14.087	14.086	20M	599	599	Amman

Sort Filter: None

UTC Call Adv

X Call DXCC Date Since Sel LotW Broke ~

DXKeeper Main Window: Award Panel

DXKeeper 8.9.4 [CC,DXV,PV,WW] - AA6YQ.mdb : 18487 QSOs

Log QSOs QSL Check Progress my QTHs Import QSOs Export QSOs

QSO: Asiatic Russia

call: RX0AT name: Vit QTH: Krasnoyarsk
 mode: RTTY via: tx freq: 14.082125 begin: 9/20/2010 01:01
 sent: 599 rcvd: 599 tx band: 20M rx freq: 14.08213 end: 9/20/2010 01:01
 power: 150 code: 15 DXCC: UA0 entity: Asiatic Russia

Award

grid: NO65kx IOTA: cont: EU WPX: RX0 CQ: 18 ITU: 29
 subyekt: KK district: ?

New Save Undo CBA Delete Report Plot 18485 Adv RAT Capture Config Help

Call	Name	DXCC	Starting UTC	Mode	Freq	RX Freq	Band	Sent	Rcvd	QTH
IK5UAN	Roberto	I	9/19/2010 10:47	RTTY	14.087	14.087	20M	599	599	Monsummano Ter. Pt
HA5VZ	Miklos	HA	9/19/2010 10:51	RTTY	14.086	14.086	20M	599	599	Budapest
UX2SB	Vasil	UT	9/19/2010 10:52	RTTY	14.086	14.086	20M	599	599	Ivano-fr. Obl.
G3WCV	Brian	G	9/19/2010 10:53	RTTY	14.086	14.086	20M	599	579	Near Oxford
OH2LZI	Heikki	OH	9/19/2010 10:55	RTTY	14.086	14.086	20M	559	599	Pernaja
DD8HB	Rolf	DL	9/19/2010 10:57	RTTY	14.086	14.086	20M	599	599	Luebeck-schlutup
JH8JYV	Hide	JA	9/19/2010 21:43	CW	18.075	18.075	17M	599	599	Sapporo-city
PJ7/N9NA	John	PJ5	9/19/2010 21:59	CW	18.075	18.075	17M	559	589	
JT5DX	Chadraabal	JT	9/19/2010 23:23	CW	18.075	18.075	17M	599	599	Mongolia
RX0AT	Vit	UA	9/20/2010 01:01	RTTY	14.082	14.082	20M	599	599	Krasnoyarsk
KP4JFR	Jose	KP4	9/20/2010 01:11	RTTY	14.083	14.083	20M	599	599	Trujillo Alto, PR
JY4NE	Ali	JY	9/20/2010 18:37	RTTY	14.087	14.086	20M	599	599	Amman

Sort Filter: None

UTC Call Adv X Call DXCC Date Since Sel LotW Broke ~

DXKeeper Main Window: Subdivision Selector

Main Administrative Subdivision Selector (Asiatic Russia)

Primary Administrative Subdivision (Subyekt)

KK	103	Krasnoyarsk (Krasnoyarsk Kraj)
Code	Oblast	Name

Secondary Administrative Subdivision (District)

Code	Abansky Area Achinsk Achinsky Area Alahtinsky Area Berezovsky Area Biriljussky Area Bogotol

DXKeeper Main Window: QSL Panel

DXKeeper 8.9.4 [CC,DXV,PV,WW] - AA6YQ.mdb : 18487 QSOs

Log QSOs QSL Check Progress my QTHs Import QSOs Export QSOs

QSO: Finland

call OH2LZI name Heikki QTH Pernaja

mode RTTY via tx freq 14.086035 begin 9/19/2010 10:55

sent 559 rcvd 599 tx band 20M rx freq 14.086042 end 9/19/2010 10:55

power 1500 code 224 DXCC OH entity Finland

QSL

sent Y R CFM date sent 10/7/2010 sent via WAZ vfy VUCC vfy

rcvd R R VFY date rcvd rcvd via IOTA vfy

msg

myQTH Wayland:IC-7800 addr Heikki Ahola
Tuomaantie 13A
FI-02180 Espoo
FINLAND

Auxiliary
 QSL
 Online QSL
 Award
 Contest
 Propagation
 Details
 User-defined

QSL Sent
 N - don't send
 R - requested
 Y - sent
 I - don't send

QSL Rcvd
 R - requested
 Y - confirmed
 S - submitted
 V - verified
 I - invalid
 X - expired

New Save Undo CBA Delete Report Plot 18480 Adv RAT Capture Config Help

Call	Name	DXCC	Starting UTC	Mode	Freq	RX Freq	Band	Sent	Rcvd	QTH
IK5UAN	Roberto	I	9/19/2010 10:47	RTTY	14.087	14.087	20M	599	599	Monsummano Ter. Pt
HA5VZ	Miklos	HA	9/19/2010 10:51	RTTY	14.086	14.086	20M	599	599	Budapest
UX2SB	Vasil	UT	9/19/2010 10:52	RTTY	14.086	14.086	20M	599	599	Ivano-fr. Obl.
G3W/CY	Brian	G	9/19/2010 10:53	RTTY	14.086	14.086	20M	599	579	Near Oxford
OH2LZI	Heikki	OH	9/19/2010 10:55	RTTY	14.086	14.086	20M	559	599	Pernaja
DD8HB	Rolf	DL	9/19/2010 10:57	RTTY	14.086	14.086	20M	599	599	Luebeck-schlutup
JH8JYV	Hide	JA	9/19/2010 21:43	Cw	18.075	18.075	17M	599	599	Sapporo-city
PJ7/N9NA	John	PJ5	9/19/2010 21:59	Cw	18.075	18.075	17M	559	589	
JT5DX	Chadraabal	JT	9/19/2010 23:23	Cw	18.075	18.075	17M	599	599	Mongolia
RX0AT	Vit	UA0	9/20/2010 01:01	RTTY	14.082	14.082	20M	599	599	Krasnoyarsk
KP4JFR	Jose	KP4	9/20/2010 01:11	RTTY	14.083	14.083	20M	599	599	Trujillo Alto, PR
JY4NE	Ali	JY	9/20/2010 18:37	RTTY	14.087	14.086	20M	599	599	Amman

Sort Filter: None

UTC Call Adv

X Call DXCC Date Since Sel LotW Broke ~

DXKeeper Main Window: Online QSL Panel

DXKeeper 8.9.4 [CC,DXV,PV,WW] - AA6YQ.mdb : 18487 QSOs

Log QSOs | QSL | Check Progress | my QTHs | Import QSOs | Export QSOs

QSO: Finland

call: OH2LZI | name: Heikki | QTH: Pernaja

mode: RTTY | via: | tx freq: 14.086035 | begin: 9/19/2010 10:55

sent: 559 | rcvd: 599 | tx band: 20M | rx freq: 14.086042 | end: 9/19/2010 10:55

power: 1500 | code: 224 | DXCC: OH | entity: Finland

QSL

sent: Y | R | CFM | date sent: 10/7/2010 | sent via: | WAZ vfy: | VUCC vfy: |

rcvd: R | R | VFY | date rcvd: | rcvd via: | IDTA vfy: |

msg: | addr: Heikki Ahola
Tuomaantie 13A
FI-02180 Espoo
FINLAND

myQTH: Wayland:IC-7800

Online QSL

eQSL.cc | sent: R | CFM | date sent: |

rcvd: | VFY | date rcvd: |

Display | member: A |

LotW | sent: Y | CFM | date sent: 9/19/2010 |

rcvd: R | VFY | date rcvd: |

member: Y |

QSL Sent: N - don't send, R - requested, Y - sent, I - don't send

QSL Rcvd: R - requested, Y - confirmed, S - submitted, V - verified, I - invalid, X - expired

New | Save | Undo | CBA | Delete | Report | Plot | 18480 | Adv | RAT | Capture | Config | Help

Call	Name	DXCC	Starting UTC	Mode	Freq	RX Freq	Band	Sent	Rcvd	QTH
IK5UAN	Roberto	I	9/19/2010 10:47	RTTY	14.087	14.087	20M	599	599	Monsummano Ter. Pt
HA5VZ	Miklos	HA	9/19/2010 10:51	RTTY	14.086	14.086	20M	599	599	Budapest
UX2SB	Vasil	UT	9/19/2010 10:52	RTTY	14.086	14.086	20M	599	599	Ivano-fr. Obl.
G3wCY	Brian	G	9/19/2010 10:53	RTTY	14.086	14.086	20M	599	579	Near Oxford
OH2LZI	Heikki	OH	9/19/2010 10:55	RTTY	14.086	14.086	20M	559	599	Pernaja
DD8HB	Rolf	DL	9/19/2010 10:57	RTTY	14.086	14.086	20M	599	599	Luebeck-schlutup
JH8JYV	Hide	JA	9/19/2010 21:43	CW	18.075	18.075	17M	599	599	Sapporo-city
PJ7/N9NA	John	PJ5	9/19/2010 21:59	CW	18.075	18.075	17M	559	589	
JT5DX	Chadraabal	JT	9/19/2010 23:23	CW	18.075	18.075	17M	599	599	Mongolia
RX0AT	Vit	UA0	9/20/2010 01:01	RTTY	14.082	14.082	20M	599	599	Krasnoyarsk
KP4JFR	Jose	KP4	9/20/2010 01:11	RTTY	14.083	14.083	20M	599	599	Trujillo Alto, PR
JY4NE	Ali	JY	9/20/2010 18:37	RTTY	14.087	14.086	20M	599	599	Amman

Sort: UTC | Call | Adv | Filter: None

Call | DXCC | Date | Since | Sel | LotW | Broke | ~

DXKeeper Main Window: Online QSL Panel

DXKeeper 8.9.4 [CC,DXV,PV,WW] - AA6YQ.mdb : 18487 QSOs

Log QSOs QSL Check Progress my QTHs Import QSOs Export QSOs

QSO: Finland

call: OH2LZI name: Heikki QTH: Pernaja

mode: RTTY via: tx freq: 14.086035 begin: 9/19/2010 10:55

sent: 559 rcvd: 599 tx band: 20M rx freq: 14.086042 end: 9/19/2010 10:55

power: 1500 code: 224 DXCC: OH entity: Finland

QSL

sent: Y R CFM date sent: 10/7/2010 sent via: WAZ vfy: VUCC vfy: Auxiliary

rcvd: R R VFY date rcvd: rcvd via: IOTA vfy: QSL

msg: Award

myQTH: Wayland:IC-7800 addr: Heikki Ahola
Tuomaantie 13A
FI-02180 Espoo
FINLAND Contest

Propagation

Details

User-defined

Online QSL

eQSL.cc sent: R CFM date sent: QSL Sent

rcvd: VFY date rcvd: R - requested

Display member: A **LotW** sent: Y CFM date sent: 9/19/2010 Y - sent

rcvd: R VFY date rcvd: I - don't send

member: Y QSL Rcvd

R - requested

Y - confirmed

S - submitted

V - verified

I - invalid

X - expired

New Save Undo CBA Delete Report Plot 18480 Adv RAT Capture Config Help

Call	Name	DXCC	Starting UTC	Mode	Freq	RX Freq	Band	Sent	Rcvd	QTH
IK5UAN	Roberto	I	9/19/2010 10:47	RTTY	14.087	14.087	20M	599	599	Monsummano Ter. Pt
HA5VZ	Miklos	HA	9/19/2010 10:51	RTTY	14.086	14.086	20M	599	599	Budapest
UX2SB	Vasil	UT	9/19/2010 10:52	RTTY	14.086	14.086	20M	599	599	Ivano-fr. Obl.
G3wCY	Brian	G	9/19/2010 10:53	RTTY	14.086	14.086	20M	599	579	Near Oxford
OH2LZI	Heikki	OH	9/19/2010 10:55	RTTY	14.086	14.086	20M	559	599	Pernaja
DD8HB	Rolf	DL	9/19/2010 10:57	RTTY	14.086	14.086	20M	599	599	Luebeck-schlutup
JH8JYV	Hide	JA	9/19/2010 21:43	CW	18.075	18.075	17M	599	599	Sapporo-city
PJ7/N9NA	John	PJ5	9/19/2010 21:59	CW	18.075	18.075	17M	559	589	
JT5DX	Chadraabal	JT	9/19/2010 23:23	CW	18.075	18.075	17M	599	599	Mongolia
RX0AT	Vit	UA0	9/20/2010 01:01	RTTY	14.082	14.082	20M	599	599	Krasnoyarsk
KP4JFR	Jose	KP4	9/20/2010 01:11	RTTY	14.083	14.083	20M	599	599	Trujillo Alto, PR
JY4NE	Ali	JY	9/20/2010 18:37	RTTY	14.087	14.086	20M	599	599	Amman

Sort: Filter: None

UTC Call Adv

X Call DXCC Date Since Sel LotW Broke ~

DXKeeper Main Window: User-defined Fields

DXKeeper 8.9.4 [CC,DXV,PV,WW] - AA6YQ.mdb : 18487 QSOs

Log QSOs QSL Check Progress my QTHs Import QSOs Export QSOs

QSO: Jordan (00:15)

call JY4NE name Ali QTH Amman

mode RTTY via tx freq 14.087 begin 9/20/2010 18:37

sent 599 rcvd 599 tx band 20M rx freq 14.086 end 9/20/2010 18:38

power 1500 code 342 DXCC JY entity Jordan

Auxiliary
 QSL
 Online QSL
 Award
 Contest
 Propagation
 Details
 User-defined

User-defined

Conditions good TX antenna

CW speed 35 TX antenna ht

DXer TX antenna el

DXLab RX antenna

New Save Undo CBA Delete Report Plot 18487 Adv RAT Capture Config Help

Call	Name	DXCC	Starting UTC	Mode	Freq	RX Freq	Band	Sent	Rcvd	QTH
IK5UAN	Roberto	I	9/19/2010 10:47	RTTY	14.087	14.087	20M	599	599	Monsummano Ter. Pt
HA5VZ	Miklos	HA	9/19/2010 10:51	RTTY	14.086	14.086	20M	599	599	Budapest
UX2SB	Vasil	UT	9/19/2010 10:52	RTTY	14.086	14.086	20M	599	599	Ivano-fr. Obl.
G3W/CY	Brian	G	9/19/2010 10:53	RTTY	14.086	14.086	20M	599	579	Near Oxford
OH2LZI	Heikki	OH	9/19/2010 10:55	RTTY	14.086	14.086	20M	559	599	Pernaja
DD8HB	Rolf	DL	9/19/2010 10:57	RTTY	14.086	14.086	20M	599	599	Luebeck-schlutup
JH8JYV	Hide	JA	9/19/2010 21:43	Cw	18.075	18.075	17M	599	599	Sapporo-city
PJ7/N9NA	John	PJ5	9/19/2010 21:59	Cw	18.075	18.075	17M	559	589	
JT5DX	Chadraabal	JT	9/19/2010 23:23	Cw	18.075	18.075	17M	599	599	Mongolia
RX0AT	Vit	UA0	9/20/2010 01:01	RTTY	14.082	14.082	20M	599	599	Krasnoyarsk
KP4JFR	Jose	KP4	9/20/2010 01:11	RTTY	14.083	14.083	20M	599	599	Trujillo Alto, PR
JY4NE	Ali	JY	9/20/2010 18:37	RTTY	14.087	14.086	20M	599	599	Amman

Sort: UTC Call Adv Filter: None

JY4NE X Call DXCC Date Since Sel LotW Broke ~

DXKeeper: Logging

- Comprehensive database
- Powerful QSO searching, sorting, and editing
- Capture window optimized for operating
- Callbook access

DXKeeper Capture Window

DXKeeper Capture @ 10/7/2010 19:40 Z

call (7)	? VQ9LA	DXCC	? VQ9
RST sent/rcvd	559 579	mode	? CW
name	Larry	tx freq	? 7.002
QTH	Fpo Ap	rx freq	7.002
pri sub	? [dropdown]	sec sub	? [dropdown]
QSL requested	<input type="checkbox"/> via DIRECT QRZ	cont	AF [dropdown]
use bureau	<input type="checkbox"/> grid MI62	CQ -- ITU	39 41
LotW member	<input checked="" type="checkbox"/> IOTA AF-006	az -- path	52 S [dropdown]
eQSL AG	<input type="checkbox"/> pwr 100	myQTH ID	Wayland:IC-780C [dropdown]
comment	~ [text area]		
contest mode	<input type="checkbox"/> ID [text]	tx# -- rx#	[text] [text]
last QSO	8/28/2010 at 0101Z on 3.50798 in CW		
Conditions	QSB [text]	TX antenna	[text]
CW speed	30 [text]	TX antenna ht	[text]
DXer	[dropdown]	TX antenna el	[text]
DXLab	[dropdown]	RX antenna	[text]

Lookup Spot End began 19:40 Z Clear Log

DXKeeper Capture Window

The screenshot shows the DXKeeper Capture window with the following fields and values:

call (7)	? VQ9LA	DXCC	? VQ9
RST sent/rcvd	559 579	mode	? CW
name	Larry	tx freq	? 7.002
QTH	Fpo Ap	rx freq	7.002

Buttons: Lookup, Spot, End, began 19:40 Z, Clear, Log

DXKeeper Capture Window

DXKeeper Capture @ 10/7/2010 19:42 Z

call (7) ? **VQ9LA** DXCC ? VQ9

RST sent/rcvd 559 579 mode ? CW

name Larry tx freq ? 7.002

QTH Fpo Ap rx freq 7.002

Lookup Spot End began 19:40 Z Clear Log

DXKeeper 8.9.4 [CC,DXV,SC,WW] - AA6YQ.mdb (filtered): 7 QSOs [QSL queue: 7 QSLs]

Log QSOs QSL Check Progress my QTHs Import QSOs Export QSOs

QSO: Chagos (2:48)

call VQ9LA name Larry QTH Fpo Ap

mode CW via DIRECT QRZ.COM tx freq 3.50798 begin 8/28/2010 01:01

sent 599 rcvd 599 tx band 80M rx freq 3.50798 end 8/28/2010 01:04

power 1500 code 33 DXCC VQ9 entity Chagos

Auxiliary
 QSL
 Online QSL
 Award
 Contest
 Propagation
 Details
 User-defined

New Save Undo CBA Delete Report Plot 7 Adv RAT Capture Config Help

Call	Name	DXCC	Starting UTC	Mode	Freq	RX Freq	Band	Sent	Rcvd	QTH
VQ9LA		VQ9	8/13/2003 01:57	RTTY	14.083		20M	59	59	
VQ9LA		VQ9	10/6/2003 01:16	CW	3.504		80M	559	599	
VQ9LA	Larry	VQ9	8/10/2009 01:57	CW	10.107	10.106	30M			Fpo Ap
VQ9LA	Larry	VQ9	9/17/2009 15:22	CW	18.087	18.085	17M			Fpo Ap
VQ9LA	Larry	VQ9	2/21/2010 01:12	CW	10.117	10.116	30M	599	599	Fpo Ap
VQ9LA	Larry	VQ9	8/8/2010 01:44	CW	7.002	7.002	40M	599	599	Fpo Ap
VQ9LA	Larry	VQ9	8/28/2010 01:01	CW	3.508	3.508	80M	599	599	Fpo Ap

Sort UTC Call Adv

Filter: Previous QSOs with VQ9LA

VQ9LA X Call DXCC Date Since Sel LotW Broke ~

DXKeeper: Logging

- Comprehensive database
- Powerful QSO searching, sorting, and editing
- Capture window optimized for operating
- Callbook access
 - The usual suspects
 - Radio Amateur's Callbook CDROM
 - Buckmaster HamCall CDROM
 - HamCall.net
 - HamQTH.com (free with no advertising)
 - QRZ local database
 - QRZ.com (free with advertising, or data subscription)
 - Update logged QSOs en masse

DXKeeper: QSLing

- Generates QSL cards and Labels
- Generates Address labels or prints envelopes
- Support for eQSL.cc and ARRL's LotW
 - One-click upload
 - One-click download and update
 - Independent tracking

DXKeeper: QSLing with Cards

DXKeeper 8.9.4 [CC,DXV,SC,WW] - AA6YQ.mdb (filtered): 30 QSOs [QSL queue: 7 QSLs]

Log QSOs **QSL** Check Progress my QTHs Import QSOs Export QSOs

QSL via

Cards 2-column labels eQSL.cc ADIF file
 3-column labels LotW tab-delimited file

Address via

Envelopes 2-column labels
 3-column labels

QSL Queue

	QSL	Call	Via	Sent Via	Begin	Mode	Band	Station call	myQTH ID
▶	<input checked="" type="checkbox"/>	JT5DX	JT1CO		9/19/2010 23:23	CW	17M	AA6YQ	wayland.ic-7800
	<input checked="" type="checkbox"/>	AP2TN	DJ9ZB	direct	9/2/2010 20:58	CW	30M	AA6YQ	wayland.ic-7800
	<input checked="" type="checkbox"/>	A51A	JA1TRC	direct	9/10/2010 23:54	CW	40M	AA6YQ	wayland.ic-7800
	<input checked="" type="checkbox"/>	VQ9LA	DIRECT QRZ.COM	direct	8/28/2010 01:01	CW	80M	AA6YQ	wayland.ic-7800
	<input checked="" type="checkbox"/>	VQ9LA	DIRECT QRZ.COM	direct	8/8/2010 01:44	CW	40M	AA6YQ	wayland.ic-7800
	<input checked="" type="checkbox"/>	VQ9LA	DIRECT QRZ.COM	direct	2/21/2010 01:12	CW	30M	AA6YQ	wayland.ic-7800
	<input checked="" type="checkbox"/>	VQ9LA	DIRECT QRZ.COM	direct	9/17/2009 15:22	CW	17M	AA6YQ	wayland.ic-7800

◀ ▶

Add Needed Add Requested Add All QSL Config ◀ ▶ ▶ ▶

Enable All Disable All Clear Help

Process QSLs and Addresses

Print QSL Cards Create Address File Address Envelopes Update Log

Print preview (QSL cards) Include QSLs to be sent via the QSL Bureau
 Include QSLs to be sent via direct mail

Self-addr envel

Print

10
batch size

DXKeeper: QSL Card Print Preview

DXKeeper Print Preview

Next Print Left margin: .117 in Width: 10.333 in
Top margin: .117 in Height: 8.267 in

Dave Bernstein
25 Glezen Lane
Wayland, MA 01778

AA6YQ

Middlesex County
FN42hi
USA

Confirming a 2X QSO with AP2TN

Date	Time	Freq	Mode	RST	QSL?	Notes
02-Sep-10	2058Z	10.102	CW	599	please!	

printed by DXLab freeware www.dxlabsuite.com

Dave Bernstein
25 Glezen Lane
Wayland, MA 01778

AA6YQ

Middlesex County
FN42hi
USA

Confirming a 2X QSO with A51A

Date	Time	Freq	Mode	RST	QSL?	Notes
10-Sep-10	2354Z	7.005	CW	599	please!	

printed by DXLab freeware www.dxlabsuite.com

Dave Bernstein
25 Glezen Lane
Wayland, MA 01778

AA6YQ

Middlesex County
FN42hi
USA

Confirming a 2X QSO with JT5DX

Date	Time	Freq	Mode	RST	QSL?	Notes
19-Sep-10	2323Z	18.075	CW	599		

printed by DXLab freeware www.dxlabsuite.com

Dave Bernstein
25 Glezen Lane
Wayland, MA 01778

AA6YQ

Middlesex County
FN42hi
USA

Confirming 2X QSOs with VQ9LA

Date	Time	Freq	Mode	RST	QSL?	Notes
17-Sep-09	1522Z	18.087	CW	599		
21-Feb-10	0112Z	10.117	CW	599		
08-Aug-10	0144Z	7.002	CW	599		
28-Aug-10	0101Z	3.508	CW	599		

printed by DXLab freeware www.dxlabsuite.com

DXKeeper: QSL Card

Dave Bernstein
25 Glezen Lane
Wayland, MA 01778

AA6YQ

Middlesex County
FN42hi
USA

Confirming 2X QSOs with VQ9LA

Date	Time	Freq	Mode	RST	QSL?	Notes
17-Sep-09	1522Z	18.087	CW	599		
21-Feb-10	0112Z	10.117	CW	599		
08-Aug-10	0144Z	7.002	CW	599		
28-Aug-10	0101Z	3.508	CW	599		

printed by DXLab freeware

www.dxlabsuite.com

DXKeeper: QSL Card with Background Image

Wayland Massachusetts
Middlesex county

AA6YQ

Grid: FN42hi
42 20' N
71 25' W

Confirming a 2X QSO with 5T0JL via ON8RA

Date	Time	Freq	Mode	RST	QSL?	Notes
29 Jul 11	1906Z	24.894	CW	579		



printed by DXLab freeware www.dxlabsuite.com

DXKeeper: QSLing with Labels

DXKeeper 8.9.4 [CC,DXV,SC,WW] - AA6YQ.mdb (filtered): 30 QSOs [QSL queue: 7 QSLs]

Log QSOs **QSL** Check Progress my QTHs Import QSOs Export QSOs

QSL via

Cards 2-column labels eQSL.cc ADIF file
 3-column labels LotW tab-delimited file

Address via

Envelopes 2-column labels
 3-column labels

QSL Queue

	QSL	Call	Via	Sent Via	Begin	Mode	Band	Station call	myQTH ID
	<input checked="" type="checkbox"/>	AP2TN	DJ9ZB	direct	9/2/2010 20:58	CW	30M	AA6YQ	wayland.ic-7800
	<input checked="" type="checkbox"/>	A51A	JA1TRC	direct	9/10/2010 23:54	CW	40M	AA6YQ	wayland.ic-7800
	<input checked="" type="checkbox"/>	JT5DX	JT1CO		9/19/2010 23:23	CW	17M	AA6YQ	wayland.ic-7800
	<input checked="" type="checkbox"/>	VQ9LA	DIRECT QRZ.COM	direct	9/17/2009 15:22	CW	17M	AA6YQ	wayland.ic-7800
	<input checked="" type="checkbox"/>	VQ9LA	DIRECT QRZ.COM	direct	2/21/2010 01:12	CW	30M	AA6YQ	wayland.ic-7800
	<input checked="" type="checkbox"/>	VQ9LA	DIRECT QRZ.COM	direct	8/8/2010 01:44	CW	40M	AA6YQ	wayland.ic-7800
	<input checked="" type="checkbox"/>	VQ9LA	DIRECT QRZ.COM	direct	8/28/2010 01:01	CW	80M	AA6YQ	wayland.ic-7800

◀ ▶

Add Needed Add Requested Add All QSL Config ◀◀ ▶▶

Enable All Disable All Clear Help

Process QSLs and Addresses

Print QSL Labels Create Address File Address Envelopes Update Log

Print preview (QSL labels) missing labels Include QSLs to be sent via the QSL Bureau
 Include QSLs to be sent via direct mail

Self-addr envel

Print

batch size

DXKeeper: QSL Card Label Preview

DXKeeper Print Preview

Next Print Left margin: .117 in Width: 8.267 in
Top margin: .117 in Height: 10.333 in

AA6YQ cfms a 2X QSO with AP2TN

Date	Time	Freq	Mode	RST
02-Sep-10	2058Z	10.102	CW	599

AA6YQ cfms a 2X QSO with A51A

Date	Time	Freq	Mode	RST
10-Sep-10	2354Z	7.005	CW	599

AA6YQ cfms a 2X QSO with JT5DX

Date	Time	Freq	Mode	RST
19-Sep-10	2323Z	18.075	CW	599

AA6YQ cfms 2X QSOs with VQ9LA

Date	Time	Freq	Mode	RST
17-Sep-09	1522Z	18.087	CW	
21-Feb-10	0112Z	10.117	CW	599
08-Aug-10	0144Z	7.002	CW	599

AA6YQ cfms 2X QSOs with VQ9LA

Date	Time	Freq	Mode	RST
28-Aug-10	0101Z	3.508	CW	599

DXKeeper: QSLing with Labels

DXKeeper 8.9.4 [CC,DXV,SC,WW] - AA6YQ.mdb (filtered): 30 QSOs [QSL queue: 7 QSLs]

Log QSOs **QSL** Check Progress my QTHs Import QSOs Export QSOs

QSL via

Cards 2-column labels eQSL.cc ADIF file
 3-column labels LotW tab-delimited file

Address via

Envelopes 2-column labels
 3-column labels

QSL Queue

	QSL	Call	Via	Sent Via	Begin	Mode	Band	Station call	myQTH ID
	<input checked="" type="checkbox"/>	AP2TN	DJ9ZB	direct	9/2/2010 20:58	CW	30M	AA6YQ	wayland.ic-7800
	<input checked="" type="checkbox"/>	A51A	JA1TRC	direct	9/10/2010 23:54	CW	40M	AA6YQ	wayland.ic-7800
	<input checked="" type="checkbox"/>	JT5DX	JT1CO		9/19/2010 23:23	CW	17M	AA6YQ	wayland.ic-7800
	<input checked="" type="checkbox"/>	VQ9LA	DIRECT QRZ.COM	direct	9/17/2009 15:22	CW	17M	AA6YQ	wayland.ic-7800
	<input checked="" type="checkbox"/>	VQ9LA	DIRECT QRZ.COM	direct	2/21/2010 01:12	CW	30M	AA6YQ	wayland.ic-7800
	<input checked="" type="checkbox"/>	VQ9LA	DIRECT QRZ.COM	direct	8/8/2010 01:44	CW	40M	AA6YQ	wayland.ic-7800
	<input checked="" type="checkbox"/>	VQ9LA	DIRECT QRZ.COM	direct	8/28/2010 01:01	CW	80M	AA6YQ	wayland.ic-7800

◀ ▶

Add Needed Add Requested Add All QSL Config ◀◀ ▶▶

Enable All Disable All Clear Help

Process QSLs and Addresses

Print QSL Labels Create Address File Address Envelopes Update Log

Print preview (QSL labels) missing labels Include QSLs to be sent via the QSL Bureau
 Include QSLs to be sent via direct mail

Self-addr envel

Print

batch size

DXKeeper: QSLing with Logbook of the World

DXKeeper 8.9.4 [CC,DXV,PV,WW] - AA6YQ.mdb : 18487 QSOs [QSL queue: 4 QSLs]

Log QSOs **QSL** Check Progress my QTHs Import QSOs Export QSOs

QSL via

Cards 2-column labels eQSL.cc ADIF file
 3-column labels LoTW tab-delimited file

Address via

Envelopes 2-column labels
 3-column labels

QSL Queue

	QSL	Call	Via	Sent Via	Begin	Mode	Band	Station call	myQTH ID
	<input checked="" type="checkbox"/>	JT5DX	: JT1CO		9/19/2010 23:23	CW	17M	AA6YQ	wayland.ic-7800
	<input checked="" type="checkbox"/>	RXQAT			9/20/2010 01:01	RTTY	20M	AA6YQ	wayland.ic-7800
	<input checked="" type="checkbox"/>	KP4JFR			9/20/2010 01:11	RTTY	20M	AA6YQ	wayland.ic-7800
	<input checked="" type="checkbox"/>	JY4NE			9/20/2010 18:37	RTTY	20M	AA6YQ	wayland.ic-7800

Buttons: Add Needed, Add Requested, Add All, QSL Config, Enable All, Disable All, Clear, Help

LotW operations

Upload to LotW: 9/20/2010 06:05:32
Sync LotW QSOs: 9/19/2010 21:05:07
Sync LotW QSLs: 9/21/2010 05:13:46

Station Location:

Self-addr envel

Print
10
batch size

DXKeeper: Award Tracking

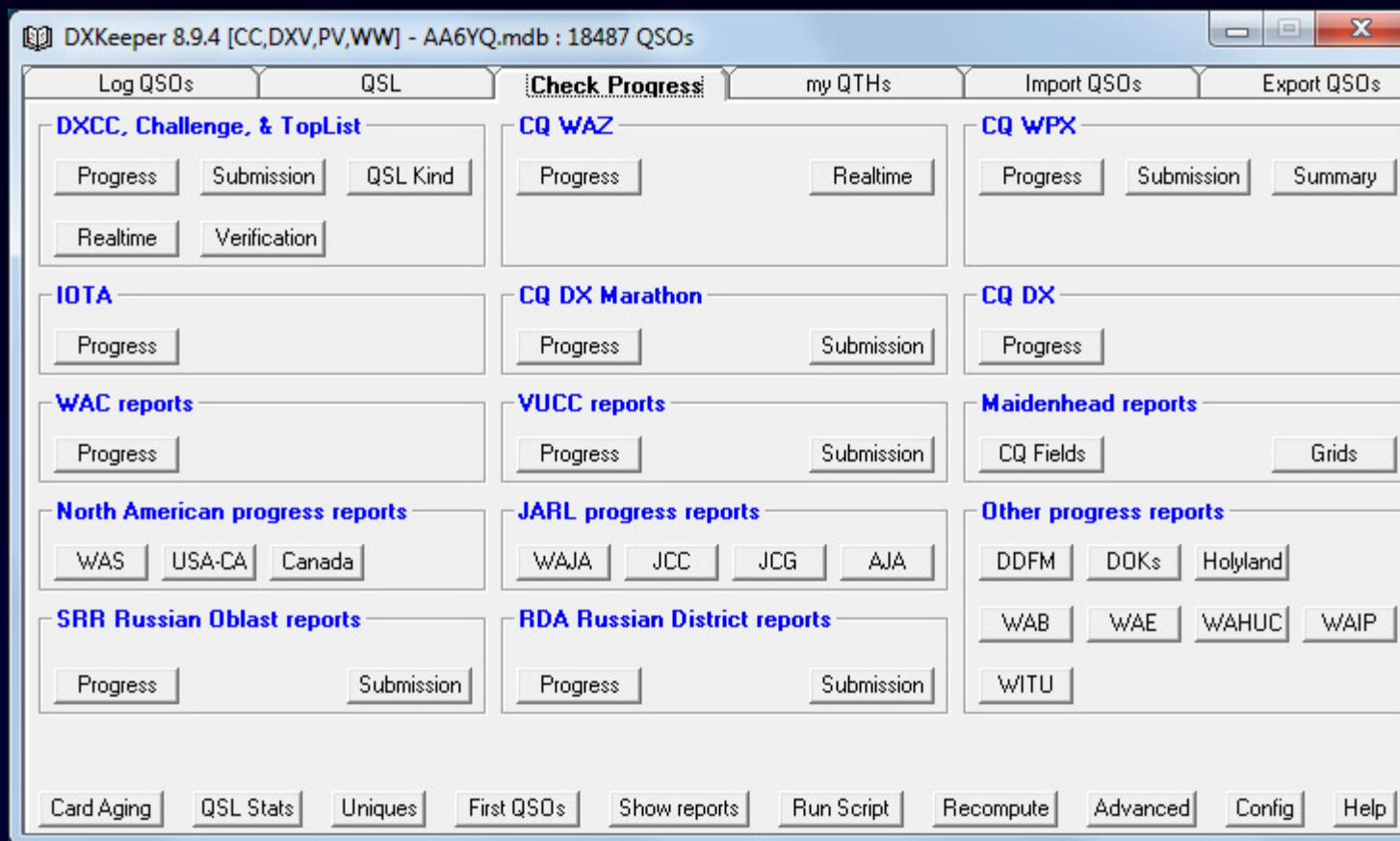

DXKeeper: Award Tracking

- DXCC* & Challenge*
 - generates submission
 - tracks verification
- CQ DX*
- CQ DX Marathon
- CQ Field*
- Gridsquares
- IOTA*
- TOPLIST*
- VUCC*
- Worked All Continents*
- Worked All Europe
- Worked All Prefixes*
- Worked All Zones*
- Worked All British Areas
- Worked All Canadian Provinces
- Worked All French Departments
- Worked All German DOKs
- Worked All Holyland Areas
- Worked All Hungarian Counties
- Worked All Italian Provinces
- Worked All Japanese Cities
- Worked All Japanese Guns
- Worked All Japanese Prefectures
- Worked All Russian Oblasts
- Worked All Russian Districts
- Worked All US States*
- Worked All US Counties*

* identifies needed confirmations

DXKeeper: Realtime Marathon Award Tracking

DXKeeper Realtime Award Tracking: KF6ZWD/HC2

DXCC, Challenge, Top **Marathon** WAZ

2011 Marathon Award Progress: 193 CQ Countries and Zones [Filter: by progress]

	Name	Mixed	SSB	CW	DIGI	160m	80m	60m	40m	30m	20m	17m	15m	12m	10m	6m	2m
▶	HC	W		W		W			W								
	HI	W		W					W								
	HK	W		W					W								
	HL	W	W						W								
	HP	W			W				W								
	HR	W		W					W								
	HV	W	W								W						
	HZ	W		W					W								
	I	W		W	W	W	W										
	IS0	W		W					W								
	IT9	W		W	W	W	W										
	J3	W		W					W								
	J6	W	W						W								
	J7	W	W				W										
	JA	W		W							W						
	JY	W	W						W								
	K	W		W		W						W					
	KH2	W		W								W					
	KH6	W		W								W					

Marathon Award Progress Filter

Band Mode Unworked Worked

Key
W - worked
Q - queued
R - requested
C - confirmed
V - verified

DXKeeper: Realtime WAZ Award Tracking

DXKeeper Realtime Award Tracking: KF6ZWD/HC2

DXCC, Challenge, Top | Marathon | **WAZ**

WAZ Award Progress: 39 Zones [Filter: by progress]

	Zone	Mixed	SSB	CW	RTTY	AM	SSTV	DIGI	160m	80m	40m	30m	20m	17m	15m	12m	10m	6m
▶	10	C	C	C	C			C	C	C	C	C	C	C	C	C	C	C
	11	C	C	C	C			C	C	C	C	C	C	C	C	C	C	C
	12	C	C	C	C			C	C	C	C	C	C	C	C	C	C	C
	13	C	C	C	C			C	C	C	C	C	C	C	C	C	C	C
	14	C	C	C	C	C		C	C	C	C	C	C	C	C	C	C	C

WAZ Award Progress Filter

Band: ANY | Unworked | Worked | Requested | Confirmed | Verified | All

Mode: MIXED | Report

CQ Zone 10 Progress Details

	160m	80m	40m	30m	20m	17m	15m	12m	10m	6m
SSB	W	C	W		C	C	C	C	C	C
CW	C	C	C	C	C	C	C	C	W	C
RTTY			W		C		C		C	
AM										
SSTV										
DIGITAL			C		C					

Key

- W - worked
- Q - queued
- R - requested
- C - confirmed
- V - verified

DXKeeper: by QSL Kind

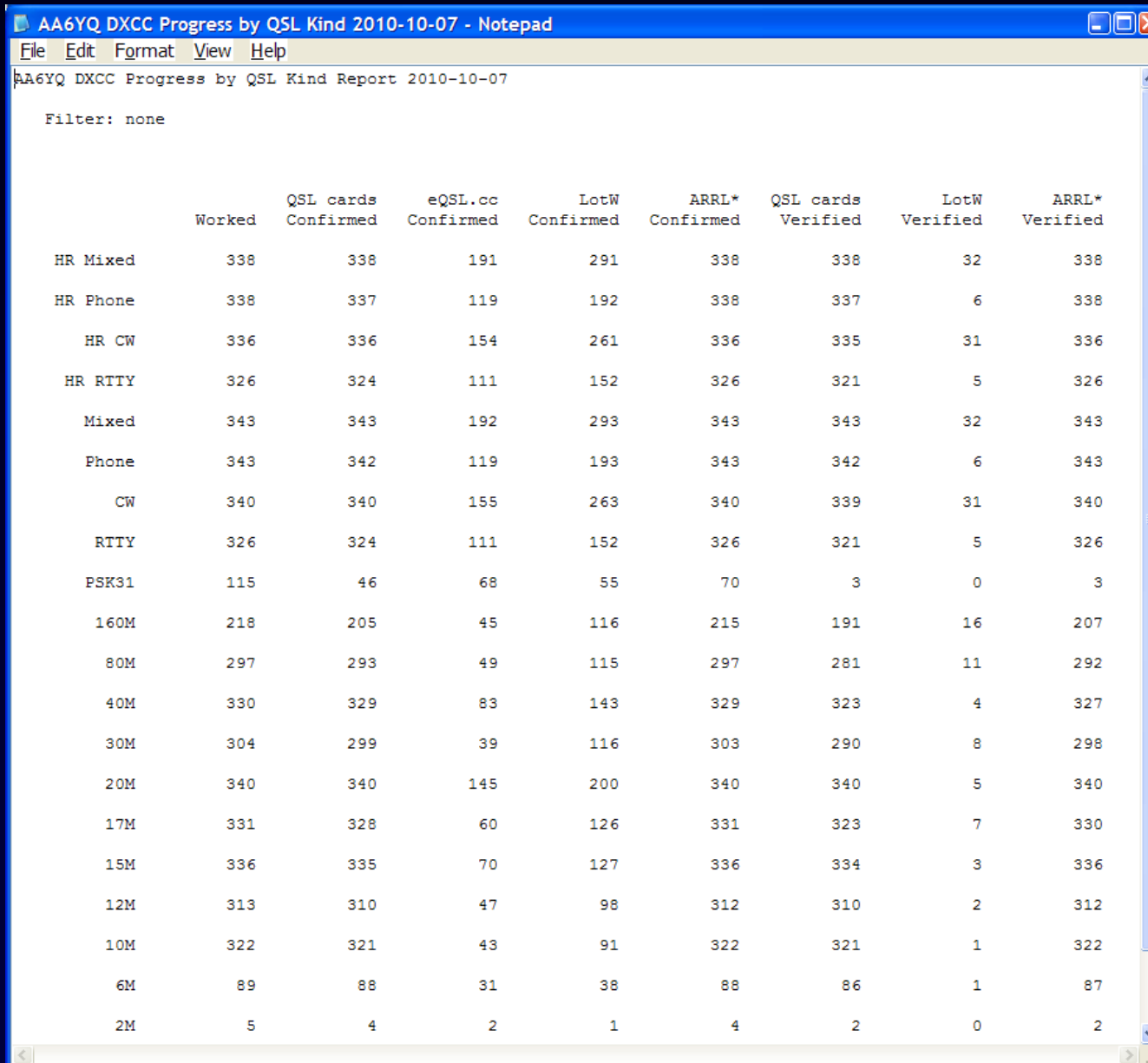

AA6YQ DXCC Progress by QSL Kind 2010-10-07 - Notepad

File Edit Format View Help

AA6YQ DXCC Progress by QSL Kind Report 2010-10-07

Filter: none

	Worked	QSL cards Confirmed	eQSL.cc Confirmed	LotW Confirmed	ARRL* Confirmed	QSL cards Verified	LotW Verified	ARRL* Verified
HR Mixed	338	338	191	291	338	338	32	338
HR Phone	338	337	119	192	338	337	6	338
HR CW	336	336	154	261	336	335	31	336
HR RTTY	326	324	111	152	326	321	5	326
Mixed	343	343	192	293	343	343	32	343
Phone	343	342	119	193	343	342	6	343
CW	340	340	155	263	340	339	31	340
RTTY	326	324	111	152	326	321	5	326
PSK31	115	46	68	55	70	3	0	3
160M	218	205	45	116	215	191	16	207
80M	297	293	49	115	297	281	11	292
40M	330	329	83	143	329	323	4	327
30M	304	299	39	116	303	290	8	298
20M	340	340	145	200	340	340	5	340
17M	331	328	60	126	331	323	7	330
15M	336	335	70	127	336	334	3	336
12M	313	310	47	98	312	310	2	312
10M	322	321	43	91	322	321	1	322
6M	89	88	31	38	88	86	1	87
2M	5	4	2	1	4	2	0	2

DXKeeper: QSL Aging

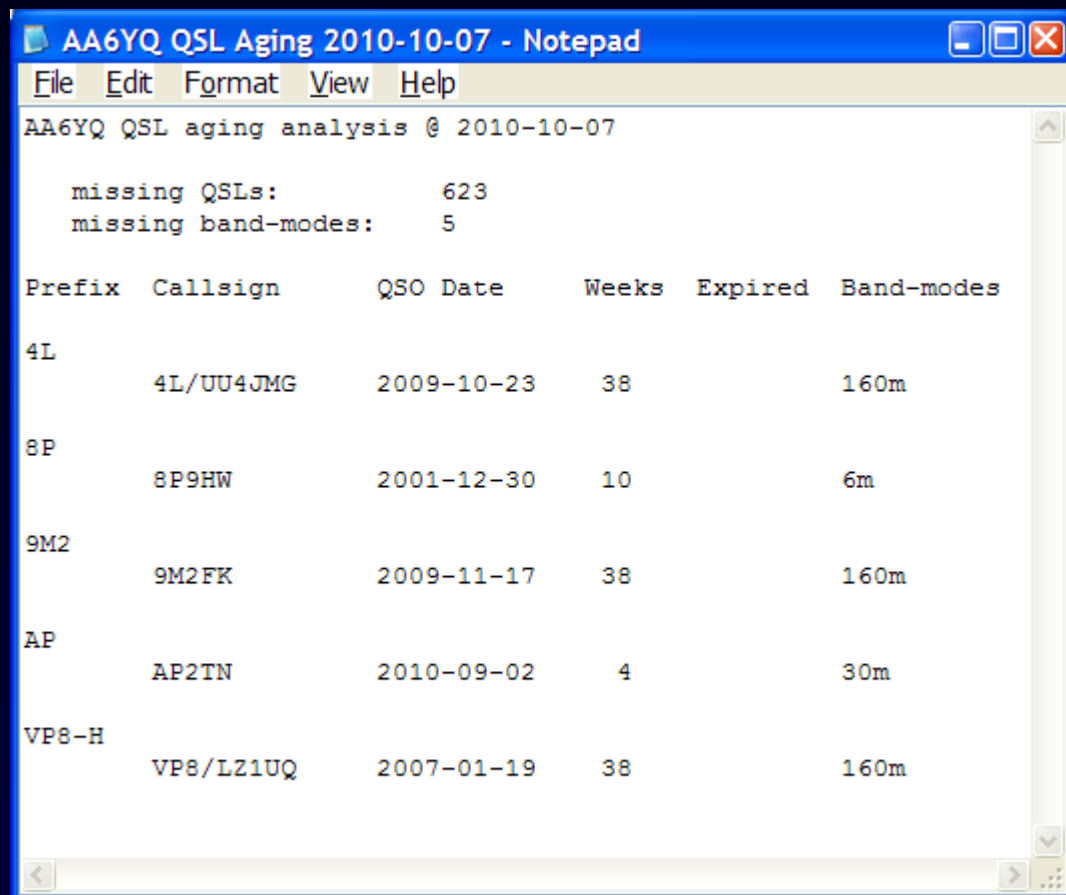

AA6YQ QSL aging analysis @ 2010-10-07

missing QSLs: 623
missing band-modes: 5

Prefix	Callsign	QSO Date	Weeks	Expired	Band-modes
4L	4L/UU4JMG	2009-10-23	38		160m
8P	8P9HW	2001-12-30	10		6m
9M2	9M2FK	2009-11-17	38		160m
AP	AP2TN	2010-09-02	4		30m
VP8-H	VP8/LZ1UQ	2007-01-19	38		160m

DXKeeper: DXCC Submission

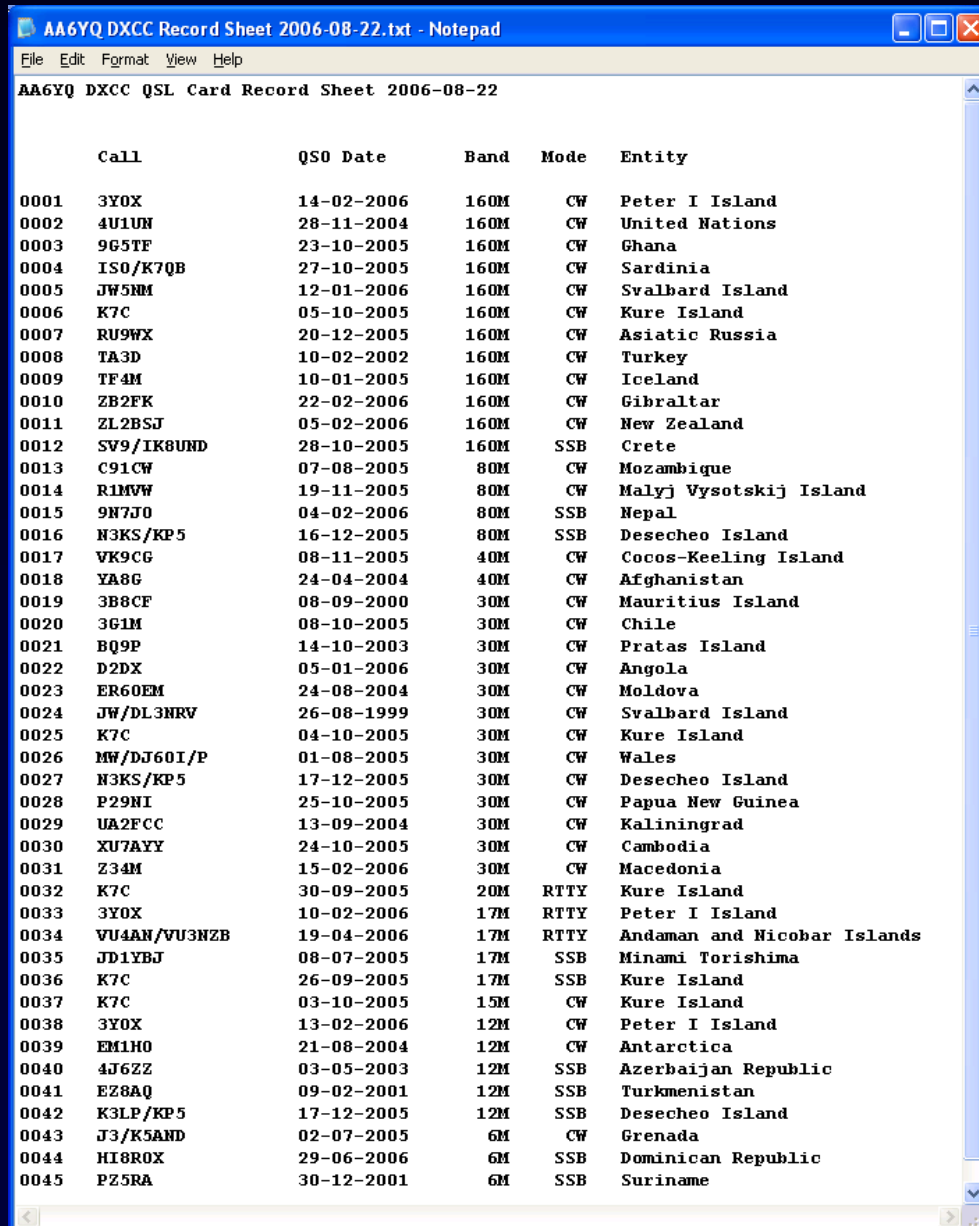

Call	QSO Date	Band	Mode	Entity	
0001	3Y0X	14-02-2006	160M	CW	Peter I Island
0002	4U1UN	28-11-2004	160M	CW	United Nations
0003	9G5TF	23-10-2005	160M	CW	Ghana
0004	IS0/K7QB	27-10-2005	160M	CW	Sardinia
0005	JW5NM	12-01-2006	160M	CW	Svalbard Island
0006	K7C	05-10-2005	160M	CW	Kure Island
0007	RU9WX	20-12-2005	160M	CW	Asiatic Russia
0008	TA3D	10-02-2002	160M	CW	Turkey
0009	TF4M	10-01-2005	160M	CW	Iceland
0010	ZB2FK	22-02-2006	160M	CW	Gibraltar
0011	ZL2BSJ	05-02-2006	160M	CW	New Zealand
0012	SV9/IK8UND	28-10-2005	160M	SSB	Crete
0013	C91CW	07-08-2005	80M	CW	Mozambique
0014	R1MWV	19-11-2005	80M	CW	Malyj Vysotskij Island
0015	9N7JO	04-02-2006	80M	SSB	Nepal
0016	N3KS/KP5	16-12-2005	80M	SSB	Desecheo Island
0017	VK9CG	08-11-2005	40M	CW	Cocos-Keeling Island
0018	YA8G	24-04-2004	40M	CW	Afghanistan
0019	3B8CF	08-09-2000	30M	CW	Mauritius Island
0020	3G1M	08-10-2005	30M	CW	Chile
0021	BQ9P	14-10-2003	30M	CW	Pratas Island
0022	D2DX	05-01-2006	30M	CW	Angola
0023	ER6OEM	24-08-2004	30M	CW	Moldova
0024	JW/DL3NRV	26-08-1999	30M	CW	Svalbard Island
0025	K7C	04-10-2005	30M	CW	Kure Island
0026	MW/DJ60I/P	01-08-2005	30M	CW	Wales
0027	N3KS/KP5	17-12-2005	30M	CW	Desecheo Island
0028	P29NI	25-10-2005	30M	CW	Papua New Guinea
0029	UA2FCC	13-09-2004	30M	CW	Kaliningrad
0030	XU7AYY	24-10-2005	30M	CW	Cambodia
0031	Z34M	15-02-2006	30M	CW	Macedonia
0032	K7C	30-09-2005	20M	RTTY	Kure Island
0033	3Y0X	10-02-2006	17M	RTTY	Peter I Island
0034	VU4AN/VU3NZB	19-04-2006	17M	RTTY	Andaman and Nicobar Islands
0035	JD1YBJ	08-07-2005	17M	SSB	Minami Torishima
0036	K7C	26-09-2005	17M	SSB	Kure Island
0037	K7C	03-10-2005	15M	CW	Kure Island
0038	3Y0X	13-02-2006	12M	CW	Peter I Island
0039	EM1HO	21-08-2004	12M	CW	Antarctica
0040	4J6ZZ	03-05-2003	12M	SSB	Azerbaijan Republic
0041	EZ8AQ	09-02-2001	12M	SSB	Turkmenistan
0042	K3LP/KP5	17-12-2005	12M	SSB	Desecheo Island
0043	J3/K5AND	02-07-2005	6M	CW	Grenada
0044	HI8ROX	29-06-2006	6M	SSB	Dominican Republic
0045	PZ5RA	30-12-2001	6M	SSB	Suriname

DXKeeper: DXCC Credit Management

- Compare granted DXCC Credits to logged QSOs
- Download Granted DXCC Credits from ARRL
 - Link DXCC Credits to logged QSOs
 - Update logged QSOs to reflect DXCC Credit Granted

the DXLab Suite

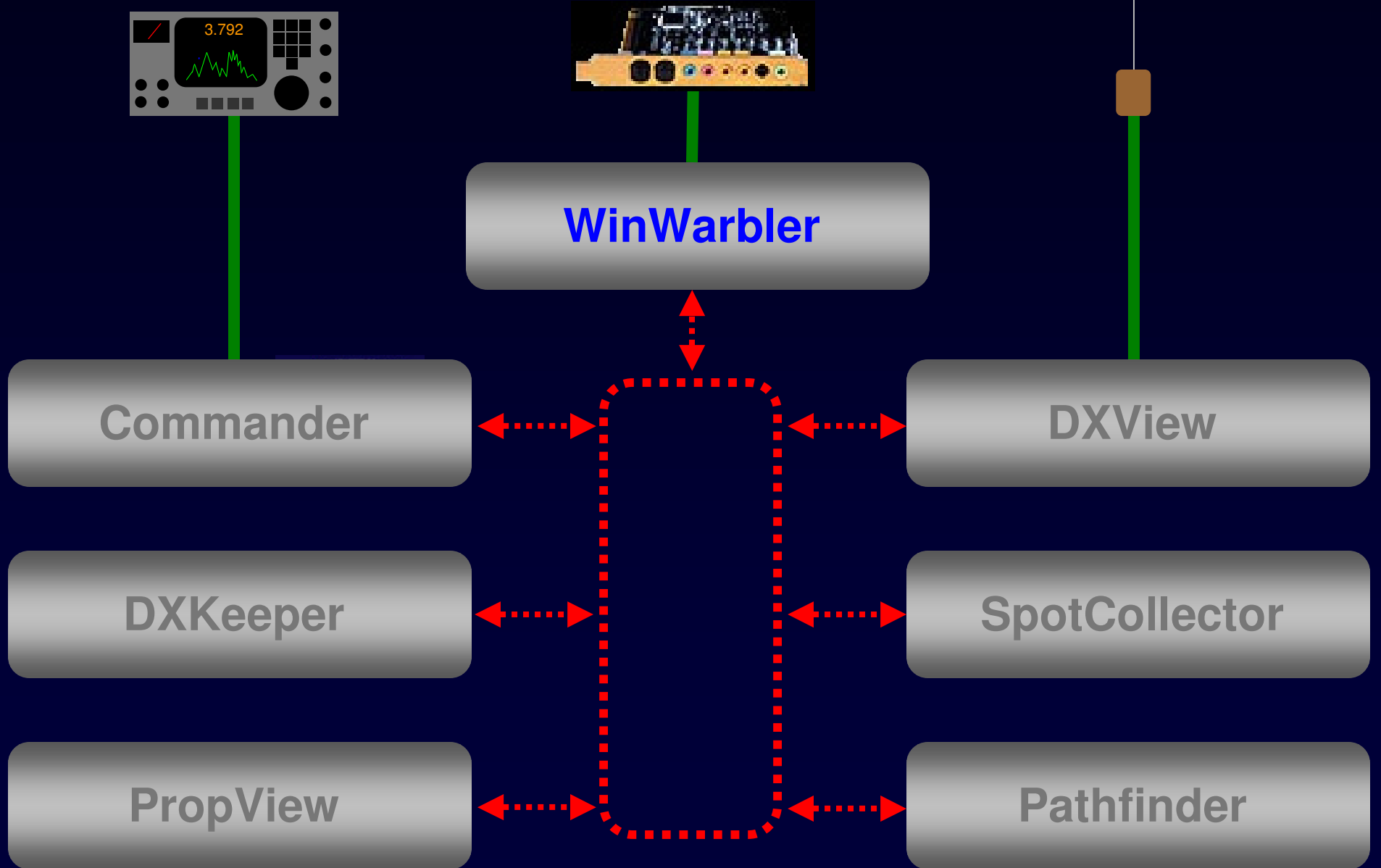

WinWarbler

- Supports PSK31, PSK63, PSK125, RTTY, CW, and Phone
- 32 macros, comprehensive macro language
- Logging
- Transceiver Control

WinWarbler: PSK31/63/125 Support

WinWarbler 6.8.5 for AA6YQ @ 2010-10-04 20:10 Z [CC,DXK,DXV,SC]

local: 2010-10-04 21:10

QSO Info (Receive Pane 2)

Call ? **DG0CG** rst S rst R Name DXCC **DL** Begin Log X

QSL Via CQ **14** ITU **28** QTH Cont **EU** End Spot

Buro Grid DOK Pri sub Sec sub

LotW IOTA Az Path **S** Comment

Xcvr Freq
RX **14,070.00**
TX **14,070.00**
Config Help

Your RST(Q): 589
0
de DK2OM btu

BTU my friend KD0EY de F4EZD KD0EY de F4EZD
1

CQ CQ CQ de DG0CG -G0CG DG0CG
pse K
CQ de DG0CG DG0CG DG0CG
2
CQ CQ CQ de DG0CG DG0CG DG0CG
pse K

Macros: psk sample

F5 CQ	F6 Call	F7 Over	F8 SK log	ALT	F9 ur report	F10 tu log qrz?	F11 mycall	F12 de mycall (3)
80m psk31	40m psk31	30m psk63	20m psk31		17m psk31	15m psk31	12m psk31	10m psk31
sh F5	sh F6	sh F7	sh F8		sh F9	sh F10	sh F11	sh F12

Operating Mode

CW PSK31
 Phone PSK63
 RTTY PSK125

Receive Channel 2 (BPSK31 USB)

Freq: **14,072.149** 7 50

AFC BBD

IMD X

p: ~

Transmit (BPSK31 USB)

Freq: **14,072.149** net split tune ID

QSO F1 F2 F3 F4 Esc

Set Freq Start CW ID Stop Abort

Tuning Display

Vert height
Horiz zoom
Horiz pan

14070 14071 14072 14073

PSK31/63/125 Broadband Decoding

chan	frequency	quality	strength	call	de call	data
03						
04						
05	14070.263	85	61			r this Bid yĭe a veryngood Ūning and been my ple3asure to have let you Hope
06	14070.379	83	52	CQ	YU7VUK	VUK pse K CQ CQ CQ de YU7VUK YU7VUK YU7VUK pse K eoo CQ CQ CQ de YU7VUK YU7VUK
07						
08				CQ	F4EAN	
09						
10				CQ	EB5DXJ	F
11				W4RIG	9A2O	
12						Si
13	14070.844	83	71	EA4KD	UR5FOG	DE UR5FOG GE DR FRIENDE FROM BOADILLA DEL MONTE ! TKS VY MUCH FR UR CALL ! UR RS
14						V
15	14070.983	88	60	JA1OY		JA1OY de Ir reRVG Hi OM tnx o er call ur rsq 599 599 m
16						
17	14071.133			PD9HJ	M6MGT	AiHW We have caunad
18	14071.207	25	39	CQ	OZ1PO	lus es I usith a bunc
19	14071.268	53	44	CQ	OZ1GEJ	Ede CQ CQ CQ CQ de OZ1A
20	14071.414	94	62	CQ	EA7IM	ietaa 7im CQ CQ CQ de ea7im ea7im e
21	14071.463	45	44	CQ	CO2VE	CQ CQ de CO2V CO2OCECQ CQ CQ de CO2VE CO2VE CO2VE ki
22						
23				CQ	G3PGA	
24	14071.653	54	33	K1RJL	IZ8DSY	iuseppe best wishes to you andt ourA
25						C
26	14071.756	76	60	OZ2BAC	CT2KAV	E SANTARÉM PORUGAL LOCATOR IMS9OE IMS9OE I iFO WWW Q Z C
27	14071.850	94	70			HAVE A IC 7000 FOR CW WHICH I ENJOY BUT KEEP THIS OLD KENWOOD FOR DIGITAL STUF
28	14071.938	89	65	CQ	CQ	t CQ DX de 2E0GHQ 2E0GHQ CQ CQ DX de 2E0GHQ CQ
29						
30	14072.091	35	31	WB1ATZ	CU7AJ	O on 20m WB1ATZ de CU7AJ sk el tt ot1K} eCPSP KB1PSP iJ K b fe à ont an ny e
31	14072.177			WP4HSZ	HK1W	
32						
33						
34						
35	14072.476	8		DL2LBO	CO2WP	PZ
36						
37						
38						
39						
40						
41						
42						
43						
44						
45						
46						
47						
48						
49						

PSK31/63/125 Broadband Decoding

WinWarbler Stations Heard								
Search		<input type="checkbox"/> DS				Opt	Config	Help
* call	frequency	qual	strength	age	#	with	data	
2E0GHQ	14071.963	81	48	000	16	CQ	CQ DX de 2E0GHQ 2E0GHQ **OUTSID EUROPE** PSE K e	
CO2VE	14071.463	50	37	003	04	CQ	im ea7im CQ CQ CQ de ea7im ea7im ea7im PSE K r	
CO2WP	14072.478	90	62	002	06	DL1BQR	Ch	
CT1ETP	14071.141	80	61	001	04	PV8ADI	a	
CT2KAV	14071.756	86	51	004	03	OZ2BAC	W8RZN W8RZN DE YO9BPX YO9BPX YO9BPX PSE K	
CU7AJ	14072.092	30	12	000	12	HP1KZ	KZ de CU7AJ Hi OM	
DL1AFM	14071.307	65	51	001	02	CQ	""LU7	
EA4KD	14070.842	91	78	000	07	UR5FOG	PRONTO ! UR5FOG GALII A p A9HASTA PRONTO GALINA 8	
EA7IM	14071.412	96	71	000	20	CQ	? QRZ? de IZ1NQY IZ1NQY IZ1NQY pse kn eit ea	
EB5DXJ	14070.642	90	66	001	10	PY2AF	e My QSL is OK via the bureau or direct no eQSL	
F4EAN	14070.480	83	51	004	06	CQ	e	
F4FFH	14070.962	93	65	000	03	CQ	Q CQ de F4FFH F4FFH F4FFH CQ CQ de F4FFH F4F	
G3PGA	14071.579	73	14	002	09	N1QEH	g with Win 7 Pro MixW 2 20 (Reg) Interface US Na	
G6UZY	14070.454	80	54	000	03	CQ		
HK1W	14072.198	78	38	004	03	WP4HSZ	DA	
HP1KZ	14072.090	85	36	000	03	CU7AJ	KZ de CU7AJ Hi OM	
IZ1NQY	14071.342	90	57	000	02	QRZ?	? QRZ? de IZ1NQY IZ1NQY IZ1NQY pse kn eit ea	
IZ5RVG	14070.983	82	46	001	02	JA1OYY	F4F	
IZ8DSY	14071.652	91	43	000	14	CQ	Q CQ DE IZ8DSY IZ8DSY IZ	
K3ML	14071.489	61	56	000	07	K3ML	ZDG pse kn h K3ML K3ML de W1LQJ W1LQJ pse k pg3	
M6FWE	14071.309	59	26	000	01	LU7HEO	""LU7	
ON4ADG	14072.171	88	62	002	02	CQ	DA	
ON5IK	14072.093	89	65	000	02	HP1KZ	KZ de CU7AJ Hi OM	
PA0BHD	14071.975	95	60	002	03	CQ	t	
PA2G	14072.354	84	40	002	08	CQ	û W	
PA38ZDG	14071.489	47	60	000	01	K3ML	ZDG pse kn h K3ML K3ML de W1LQJ W1LQJ pse k pg3	
PA3ZDG	14070.994	66	79	001	06	CQ	F4F	
PD0MJC	14071.814	95	65	001	08	CQ	W8RZN W8RZN DE YO9BPX YO9BPX YO9BPX PSE K	
PD9HJ	14071.135	71	52	005	03	CQ	a	
TA1BX	14071.470	85	53	001	06	CQ		
UR5FOG	14070.845	78	53	005	04	EA4KD	PRONTO ! UR5FOG GALII A p A9HASTA PRONTO GALINA 8	
W1LQJ	14071.488	91	58	000	04	K3ML	ZDG pse kn h K3ML K3ML de W1LQJ W1LQJ pse k pg3	
YO9BPX	14071.812	94	55	000	02	W8RZN	W8RZN W8RZN DE YO9BPX YO9BPX YO9BPX PSE K	
YU7VUK	14070.379	83	52	003	06	CQ	o	

WinWarbler RTTY Support

- Soundcard RTTY
 - uses JE3HHT's MMTTY engine
- External modem: diversity decoding
 - KAM
 - PK232
 - PK900
 - MFJ
 - SCS

WinWarbler RTTY Support

WinWarbler 6.8.5 for AA6YQ @ 2010-10-04 20:04 Z [CC,DXK,DXV,SC]

local: 2010-10-04 21:04

QSO Info (Receive Pane 0)

Call ? LX8RTTY rst S rst R Name Andy DXCC LX Begin Log X
QSL Via CQ 14 ITU 27 QTH Schifflange Cont EU End Spot ↑
Buro Grid JN39am Pri sub Sec sub
LotW IOTA Az Path S Comment

Xcvr Freq
RX 14,087.21
TX 14,087.21
Config Help

E ISAVE FUN WITVTHE RADIO
MORE INFOS ON QRZ.COM AND FACEBOOK.COM
VE5TLW DE LX8RTTY
PSE K

Macros: rtty sample

F5 CQ sh F5	F6 Call sh F6	F7 Over sh F7	F8 SK log sh F8	ALT	F9 ur rpt sh F9	F10 tu log qrz? sh F10	F11 de mycall sh F11	F12 mycall (3) sh F12
-------------------	---------------------	---------------------	-----------------------	-----	-----------------------	------------------------------	----------------------------	-----------------------------

RTTY receive (soundcard)
Freq: 14,085.085 Signal level & squelch 41
 AFC Notch Profile AA6YQ
 BPF DPF
 Reverse Def Opt

RTTY transmit (soundcard)
Freq: 14,085.085 net tune
F2 F4 Esc
 Reverse Start Stop Abort

Operating Mode
 CW PSK31
 Phone PSK63
 RTTY PSK125

Tuning Display
Vert height 2.0
Horiz zoom 1
Horiz pan

14084 14085 14086 14087

WinWarbler

- CW transmission
 - software-generated
 - WinKey
 - external modem
- Phone voice keyer
- Logging
 - Built-in minilog
 - Automatically logs to DXKeeper if running
- Transceiver control via Commander
 - Logs correct frequencies
 - One-click QSY to optimize tone within transceiver bandwidth
 - RX-TX switching

the DXLab Suite

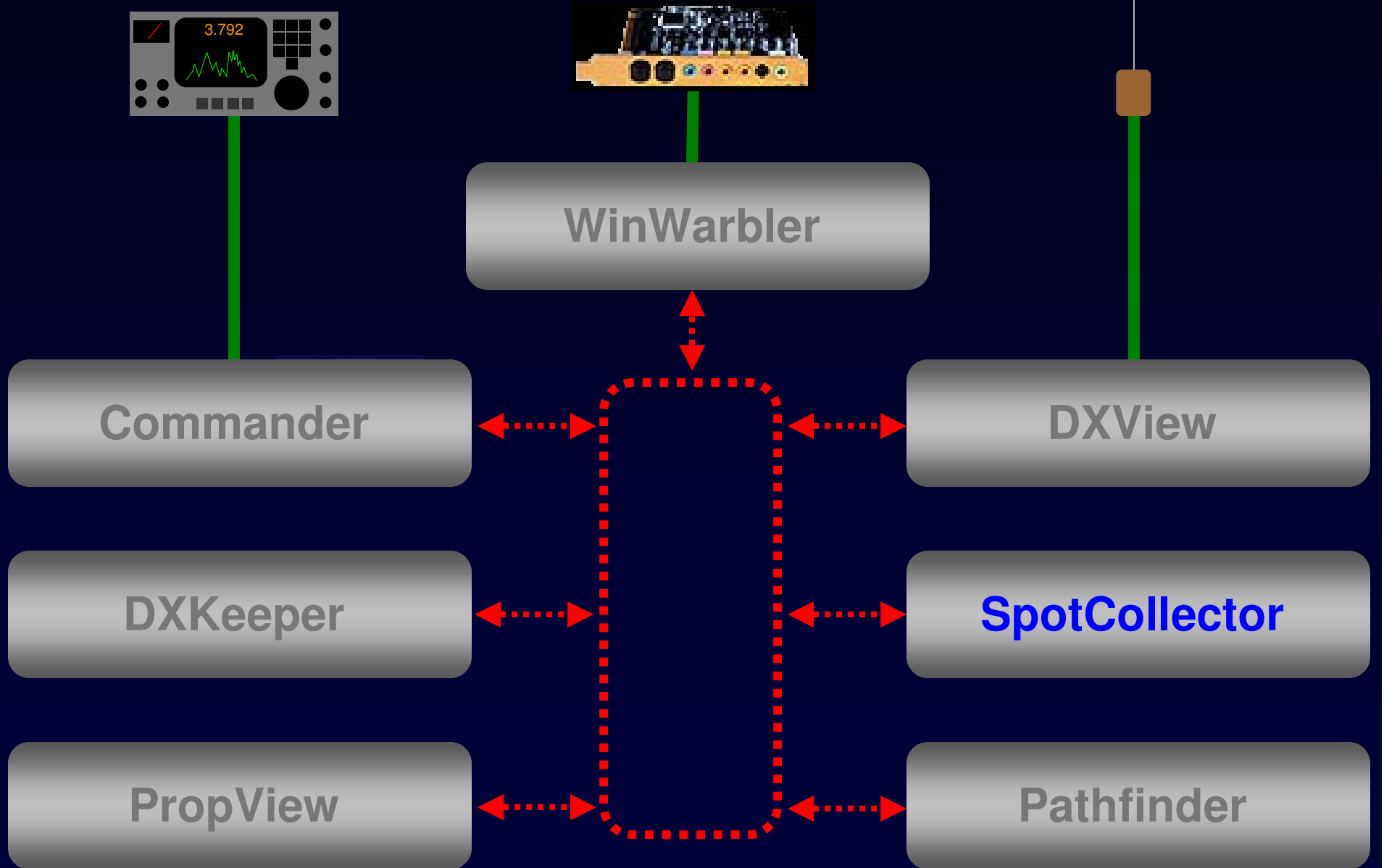

SpotCollector

- Connects to six spot sources
 - Four telnet clusters
 - DX Summit web cluster
 - Local packet cluster via external TNC
- Captures DX spots and places them into a database with **one entry for each active DX station**
- Highlights and announces “needed” stations
 - DXCC, Challenge, & TopList
 - CQ Marathon
 - CQ WAZ
- Captures WWV spots

SpotCollector: DX Spot Database

- Discards bogus spots (B0ZO, SL1M, etc.)
- Combines spots of same DX station
- Filters database by
 - Need
 - Frequency
 - Continent
 - Callsign
 - Band
 - Origin
 - Country
 - Mode
 - Distance from spotting station
- Colors database entries
 - by Need
 - by LotW participation and date of last upload
 - By eQSL AG membership
 - by Callsign matching
- Plots
 - Spots and QSOs on DXView's world map
 - Spots on Commander's bandspread

SpotCollector: DX Spot Database

SpotCollector 5.3.9 @ 2010-10-07 17:31 Z [CC,DXK,DXV,WW] (log: AA6YQ.mdb)

WWV 10-07 1506 Z

SFI 74 History

Outgoing spot

Call: 7,002.0 Freq Cluster

Notes: X Local

Spot source status

Report Stats Config Help

Call	Pfx	Freq	QSO	Band	Mode	First	Last	CQ	ITU	IOTA	Region	Azimuth	NAE	NAM	NAW	SA	EU	AF	AS	OC	UN	LastOrigin	Source	Notes
ZS6GRL	ZS	21,070.4		15M	PSK	07 1641	07 1728	38	57		South Africa	108					Y					EU	MM0GZZ	BPSK31 nice strong qso
PY2FDX	PY	28,460.0		10M	SSB	07 1722	07 1728	11	15		Sao Paulo	158					Y					EU	F5DQK	55 QSB
FR1LB	FR-R	14,140.0		20M	CW	07 1636	07 1729	39	53	AF-016	Reunion Island	80					Y	Y				EU	PD2YA	TNX FOR 58 QRP
GMOBK/M	GM	14,219.0		20M	SSB	07 1722	07 1729	14	27		Scotland	47					Y					EU	EA1HVV	5/9 Thank Paul
EA1HLW	EA	7,140.0		40M	CW	07 1729	07 1729	14	37		Spain	68					Y					EU	EA7IC	5/9-73 ANGELES FROM
OZ1GX	OZ	28,022.0		10M	CW	07 1729	07 1729	14	18		Denmark	43					Y					EU	OZ3BJ	cq nac J04
9M6DXX	9M6	14,265.0	14,270.0	20M	SSB	07 1729	07 1729	28	54		East Malaysia	351					Y					EU	EA7GWA	5/9 5 up
YU1KN	YU	7,146.0		40M	CW	07 1729	07 1729	15	28		Serbia	52					Y					EU	DL2BK	Sase KNO:
VU0WFF	VU	7,006.3		40M	CW	07 1715	07 1729	22	41		India	26					Y		Y			EU	UR5IAW	VUJFF-101
DJ5KX/P	DL	7,018.0		40M	CW	07 1730	07 1730	14	28		Germany	50					Y					EU	DL0AD	DLFF-112
9M6DXX/P	9M6	14,265.0	14,270.0	20M	SSB	07 1701	07 1731	28	54		East Malaysia	351			Y		Y					NA-W	KB6NAN	simplex now IOTA OC-1
OJ0B	OJ0	7,003.0	7,004.9	40M	CW	07 1620	07 1731	15	18	EU-053	Market Reef	37					Y		Y			EU	ON4LO	up JP90
UN7QX	UN	10,108.0		30M	CW	07 1731	07 1731	17	31		Alma-Atinskaya	18					Y					EU	S52DD	MN83
JT5DX	JT	3,504.0	3,505.3	80M	CW	07 1706	07 1731	23			Mongolia	1					Y		Y			EU	PA4VHF	up1.3 sri freq
DH8A	DH	28,032.0		10M	CW	07 1731	07 1731	15	18		Finland	36					Y					EU	SK2AT	NAC CW
EB2GPF	EA	7,115.0		40M	CW	07 1731	07 1731	14	37		Spain	68					Y					EU	EA2DT	5/9 TNX Miguel

Sort: First Call Last Freq Rcv Az

Filter: Band and Mode and Origin

AutoHide Audio LotW eQSL ALT

Call DXCC Freq Tag Band Mode Cont Origin

SQL 1 SQL 2 SQL 3 SQL 4 SQL 5 SQL 6 SQL 7 SQL 8

Color codes

- verified
- unneeded
- unconfrmd
- unwrkd B or M
- unwrkd counter
- special tag
- LotW
- eQSL AG
- LotW & eQSL AG

SpotCollector: Cumulative Spot Notes

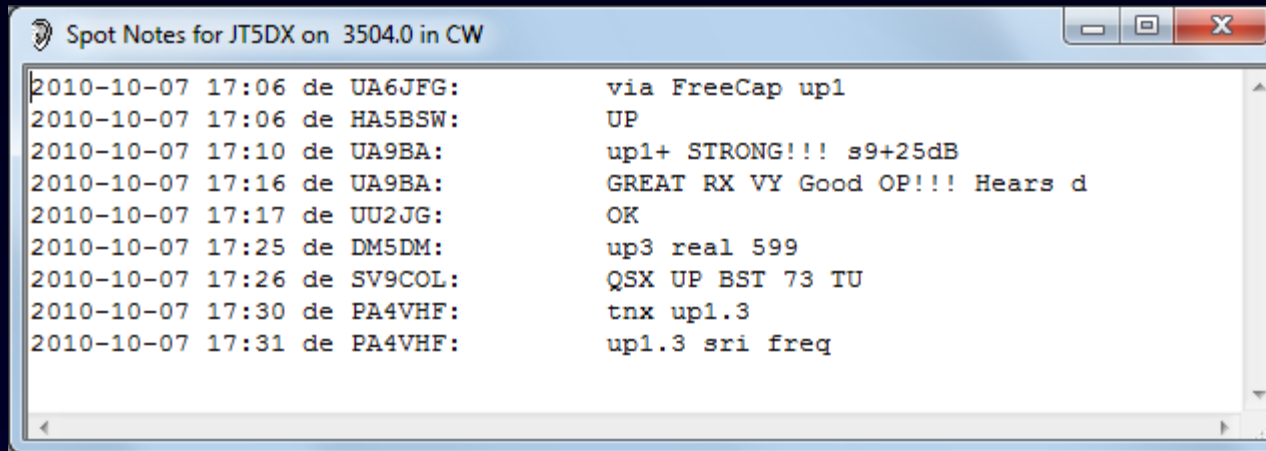

```
Spot Notes for JT5DX on 3504.0 in CW
2010-10-07 17:06 de UA6JFG:      via FreeCap up1
2010-10-07 17:06 de HA5BSW:      UP
2010-10-07 17:10 de UA9BA:      up1+ STRONG!!! s9+25dB
2010-10-07 17:16 de UA9BA:      GREAT RX VY Good OP!!! Hears d
2010-10-07 17:17 de UU2JG:      OK
2010-10-07 17:25 de DM5DM:      up3 real 599
2010-10-07 17:26 de SV9COL:      QSX UP BST 73 TU
2010-10-07 17:30 de PA4VHF:      tnx up1.3
2010-10-07 17:31 de PA4VHF:      up1.3 sri freq
```

SpotCollector: DX Spot Database

SpotCollector 5.3.9 @ 2010-10-07 17:31 Z [CC,DXK,DXV,WW] (log: AA6YQ.mdb)

WWV 10-07 1506 Z

SFI 74 History

Outgoing spot

Call: 7,002.0 Freq Cluster

Notes: X Local

Spot source status

Report Stats Config Help

Call	Pfx	Freq	QSO	Band	Mode	First	Last	CQ	ITU	IOTA	Region	Azimuth	NAE	NAM	NAW	SA	EU	AF	AS	OC	UN	LastOrigin	Source	Notes
ZS6GRL	ZS	21,070.4		15M	PSK	07 1641	07 1728	38	57		South Africa	108					Y					EU	MM0GZZ	BPSK31 nice strong qso
PY2FDX	PY	28,460.0		10M	SSB	07 1722	07 1728	11	15		Sao Paulo	158					Y					EU	F5DQK	55 QSB
FR1LB	FR-R	14,140.0		20M	CW	07 1636	07 1729	39	53	AF-016	Reunion Island	80					Y	Y				EU	PD2YA	TNX FOR 58 QRP
GMOBK/M	GM	14,219.0		20M	SSB	07 1722	07 1729	14	27		Scotland	47					Y					EU	EA1HVV	5/9 Thank Paul
EA1HLW	EA	7,140.0		40M	CW	07 1729	07 1729	14	37		Spain	68					Y					EU	EA7IC	5/9-73 ANGELES FROM
OZ1GX	OZ	28,022.0		10M	CW	07 1729	07 1729	14	18		Denmark	43					Y					EU	OZ3BJ	cq nac JO4
9M6DXX	9M6	14,265.0	14,270.0	20M	SSB	07 1729	07 1729	28	54		East Malaysia	351					Y					EU	EA7GWA	5/9 5 up
YU1KN	YU	7,146.0		40M	CW	07 1729	07 1729	15	28		Serbia	52					Y					EU	DL2BK	Sase KNO:
VU0WFF	VU	7,006.3		40M	CW	07 1715	07 1729	22	41		India	26					Y		Y			EU	UR5IAW	VUJFF-101
DJ5KX/P	DL	7,018.0		40M	CW	07 1730	07 1730	14	28		Germany	50					Y					EU	DL0AD	DLFF-112
9M6DXX/P	9M6	14,265.0	14,270.0	20M	SSB	07 1701	07 1731	28	54		East Malaysia	351			Y		Y					NA-W	KB6NAN	simplex now IOTA OC-1
OJ0B	OJ0	7,003.0	7,004.9	40M	CW	07 1620	07 1731	15	18	EU-053	Market Reef	37					Y		Y			EU	ON4LO	up JP90
UN7QX	UN	10,108.0		30M	CW	07 1731	07 1731	17	31		Alma-Atinskaya	18					Y					EU	S52DD	MN83
JT5DX	JT	3,504.0	3,505.3	80M	CW	07 1706	07 1731	23			Mongolia	1					Y		Y			EU	PA4VHF	up1.3 sri freq
DH8A	DH	28,032.0		10M	CW	07 1731	07 1731	15	18		Finland	36					Y					EU	SK2AT	NAC CW
EB2GPF	EA	7,115.0		40M	CW	07 1731	07 1731	14	37		Spain	68					Y					EU	EA2DT	5/9 TNX Miguel

Sort: First Call Last Freq Rcv Az

Filter: Band and Mode and Origin

AutoHide Audio LotW eQSL ALT

Call DXCC Freq Tag Band Mode Cont Origin

SQL 1 SQL 2 SQL 3 SQL 4 SQL 5 SQL 6 SQL 7 SQL 8

Color codes

- verified
- unneeded
- unconfrmd
- unwrkd B or M
- unwrkd counter
- special tag
- LotW
- eQSL AG
- LotW & eQSL AG

SpotCollector: "Needed"

SpotCollector 5.3.9 @ 2010-10-07 17:33 Z [CC,DXK,DXV,WW] (log: AA6YQ.mdb)

WWV 10-07 1506 Z

SFI 74 History

Q: 1 A 6 2 K

Outgoing spot

Call [] 7,002.0 Freq Cluster

Notes [] X Local

Spot source status

Report Stats Config Help

Call	Pfx	Freq	QSO	Band	Mode	First	Last	CQ	ITU	IOTA	Region	Azimuth	NAE	NAM	NAW	SA	EU	AF	AS	OC	UN	LastOrigin	Source	Notes
KH2/N2NL	KH2	1,817.5		160M	CW	07 1123	07 1128	27	64	OC-026	Guam and Mariana I	321	Y	Y						Y		NA-E	K3TW/4	579 on 80m dipole in FL
XU7ACY	XU	1,815.0		160M	CW	07 1054	07 1149	26	49		Cambodia	4	Y							Y		AS	XU7TZG	cq
VK8VF/B	VK	50,310.0		6M	FM	07 1200	07 1200	29	55		Northern Territory	308								Y		AS	JE6AZU	539
BT4EXPO	BY	1,815.0		160M	CW	07 1227	07 1227	24	44		Shang Hai	349								Y		AS	UA0BA	
VK8MS	VK	50,110.0		6M	SSB	07 1228	07 1228	29	55		Northern Territory	308								Y		AS	JE6AZU	59 IN PM51 P
BU2AQ	BV	1,822.6		160M	CW	07 1317	07 1317	24	44		Taiwan	346			Y							NA-W	N6VR/7	cq, now 559
JT5DX	JT	3,504.1		80M	CW	07 1330	07 1353	23			Mongolia	1			Y					Y		NA-W	N6ZN	459 n. ca
9M6XRO/P	9M6	10,107.3		30M	CW	07 1449	07 1449	28	54		East Malaysia	351					Y					EU	DL4NY	OC133 Tks John & Stev
9M6DXX/P	9M6	10,104.0	10,105.0	30M	CW	07 1450	07 1450	28	54		East Malaysia	351					Y					EU	RA7A	UP
V85TL	V8	3,504.0		80M	CW	07 1516	07 1516	28	54		Brunei	351					Y					EU	SM5CRV	cq
V85TL	V8	10,107.4		30M	CW	07 1524	07 1524	28	54		Brunei	351			Y							NA-W	KD7H	now hr clg CQ
V85TL	V8	10,103.1		30M	CW	07 1528	07 1602	28	54		Brunei	351			Y		Y					EU	SP9CDA	Tnx
9M6XRO/P	9M6	10,104.0	10,107.0	30M	CW	07 1415	07 1720	28	54		East Malaysia	351	Y	Y			Y	Y				EU	LZ2NP	up
JT5DX	JT	3,504.0	3,505.3	80M	CW	07 1706	07 1731	23			Mongolia	1					Y		Y			EU	PA4VHF	up 1.3 sri freq

Sort: First Call Last Freq Rcv Az

Filter: Band and Mode and Origin and [entity- band or mode unworked]

Need Call DXCC Freq Tag Band Mode Cont Origin

AutoHide Audio LotW eQSL ALT SQL 1 SQL 2 SQL 3 SQL 4 SQL 5 SQL 6 SQL 7 SQL 8

Color codes

- verified
- unneeded
- unconfm'd
- unwrkd B or M
- unwrkd counter
- special tag
- LotW
- eQSL AG
- LotW & eQSL AG

SpotCollector: "Needed" and spotted from NA-E

SpotCollector 5.3.9 @ 2010-10-07 17:34 Z [CC,DXK,DXV,WW] (log: AA6YQ.mdb)

WWV 10-07 1506 Z

SFI 74 History

Q: 0 A 6 2 K

Outgoing spot

Call 7,002.0 Freq Cluster

Notes X Local

Spot source status

Report Stats Config Help

Call	Pfx	Freq	QSO	Band	Mode	First	Last	CQ	ITU	IOTA	Region	Azimuth	NAE	NAM	NAW	SA	EU	AF	AS	OC	UN	LastOrigin	Source	Notes
KH2/N2NL	KH2	1,817.5		160M	CW	07 1123	07 1128	27	64	OC-026	Guam and Mariana I	321	Y	Y					Y			NA-E	K3TW/4	579 on 80m dipole in FL.
XU7ACY	XU	1,815.0		160M	CW	07 1054	07 1149	26	49		Cambodia	4	Y						Y			AS	XU7TZG	cq

Sort

First Call
 Last Freq
 Rcv Az

Filter: Band and Mode and Origin and [entity- band or mode unworked]

X Need Call DXCC Freq Tag Band Mode Cont Origin

AutoHide Audio LotW eQSL ALT

SQL 1 SQL 2 SQL 3 SQL 4 SQL 5 SQL 6 SQL 7 SQL 8

Color codes

- verified
- unneeded
- unconfmrd
- unwrkd B or M
- unwrkd counter
- special tag
- LotW
- eQSL AG
- LotW & eQSL AG

SpotCollector: DX Spot Database

- Discards bogus spots (B0ZO, SL1M, etc.)
- Combines spots of same DX station
- Filters database by
 - Need
 - Frequency
 - Continent
 - Callsign
 - Band
 - Origin
 - Country
 - Mode
 - Distance from spotting station
- Colors database entries
 - by Need
 - by LotW participation and date of last upload
 - By eQSL AG membership
 - by Callsign matching
- Plots
 - Spots and QSOs on DXView's world map
 - Spots on Commander's bandspread

SpotCollector: Plotted DX

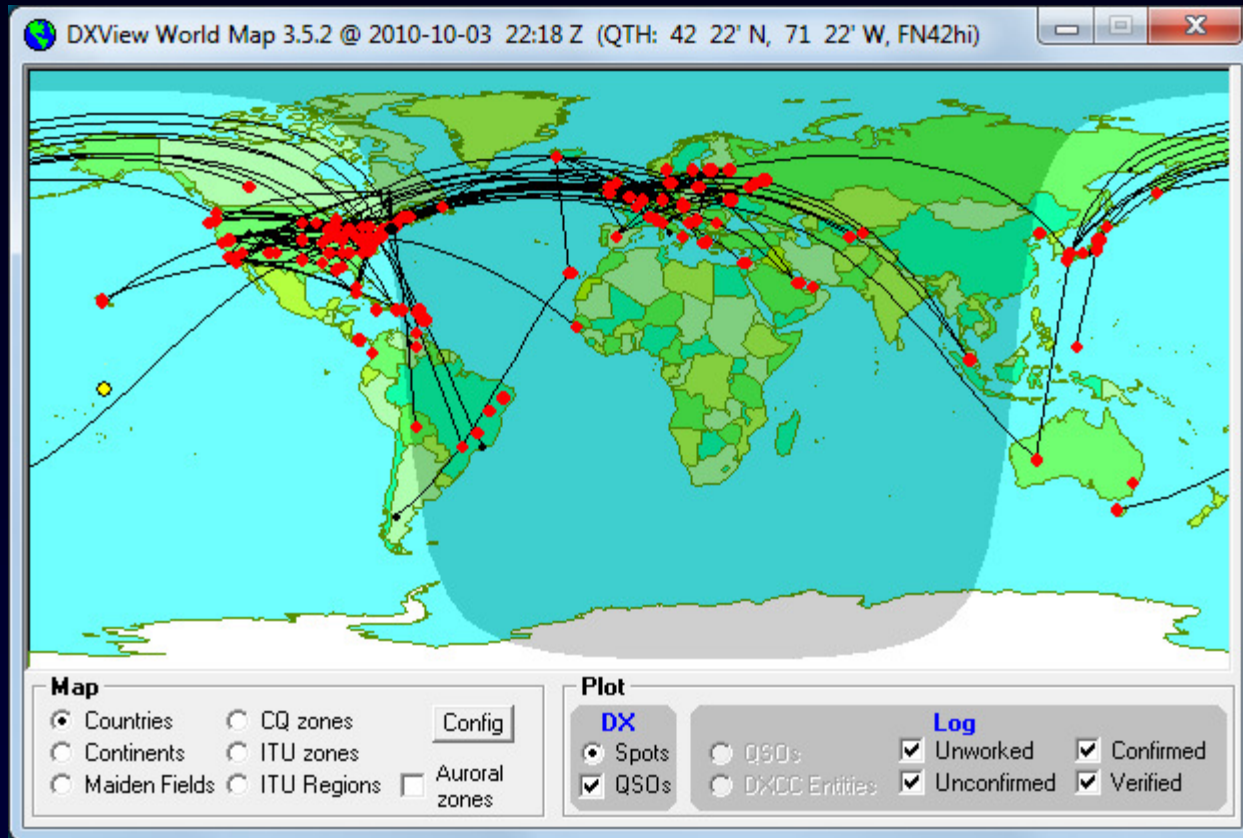

SpotCollector: Plotted 160m DX

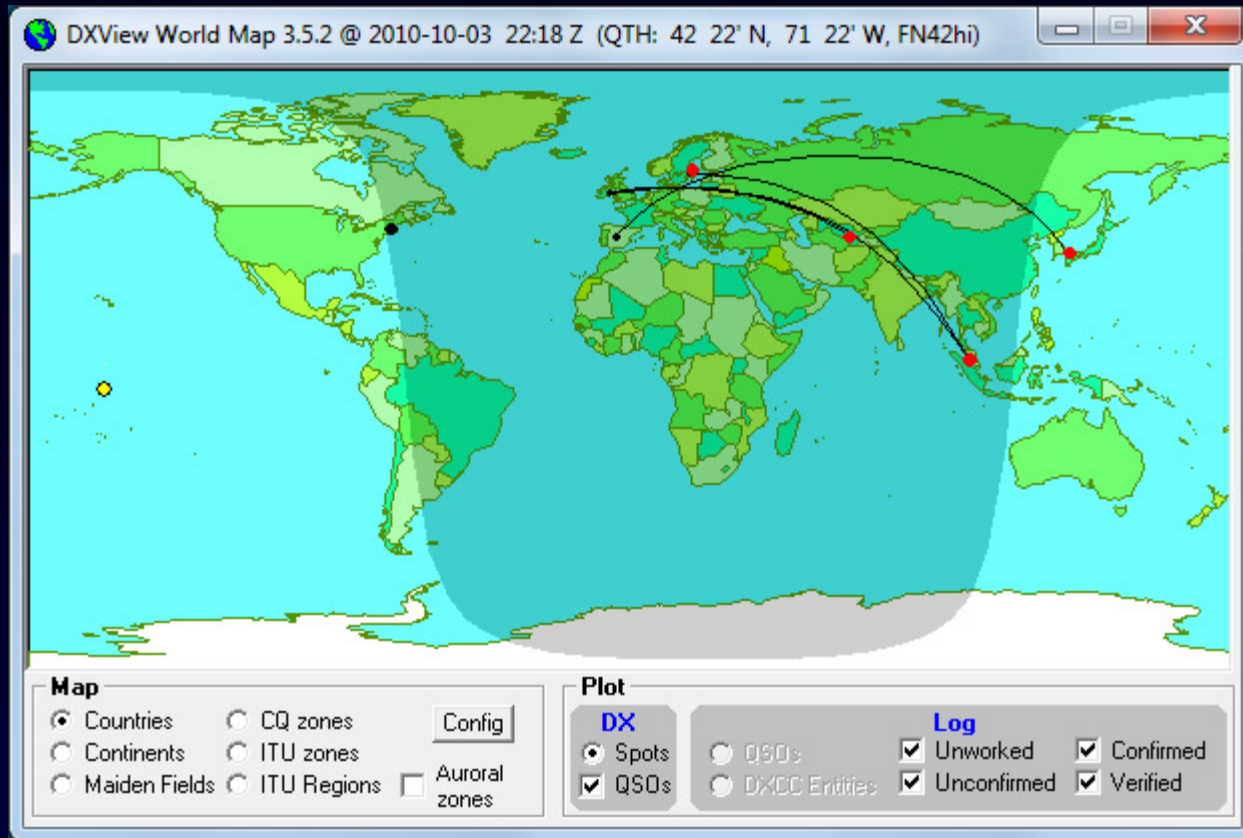

SpotCollector: Plotted 80m DX

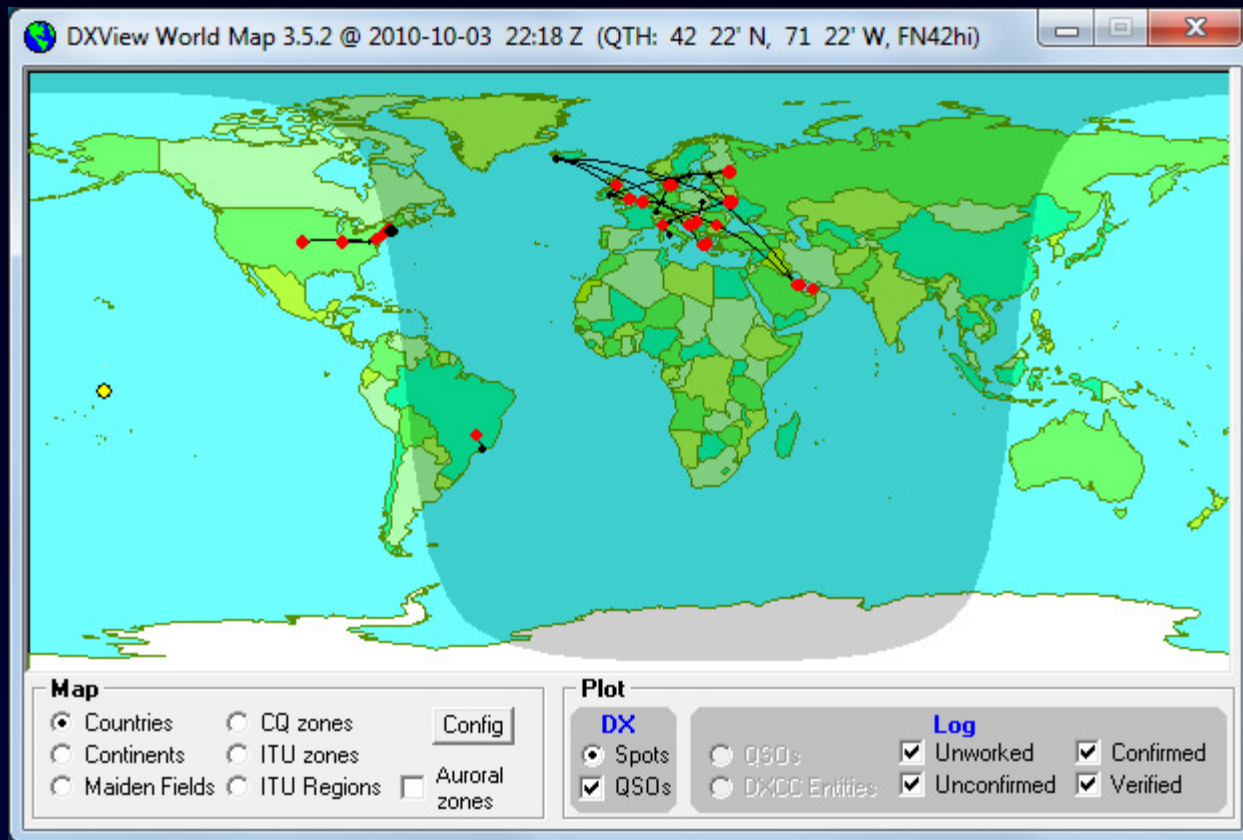

SpotCollector: Plotted 40m DX

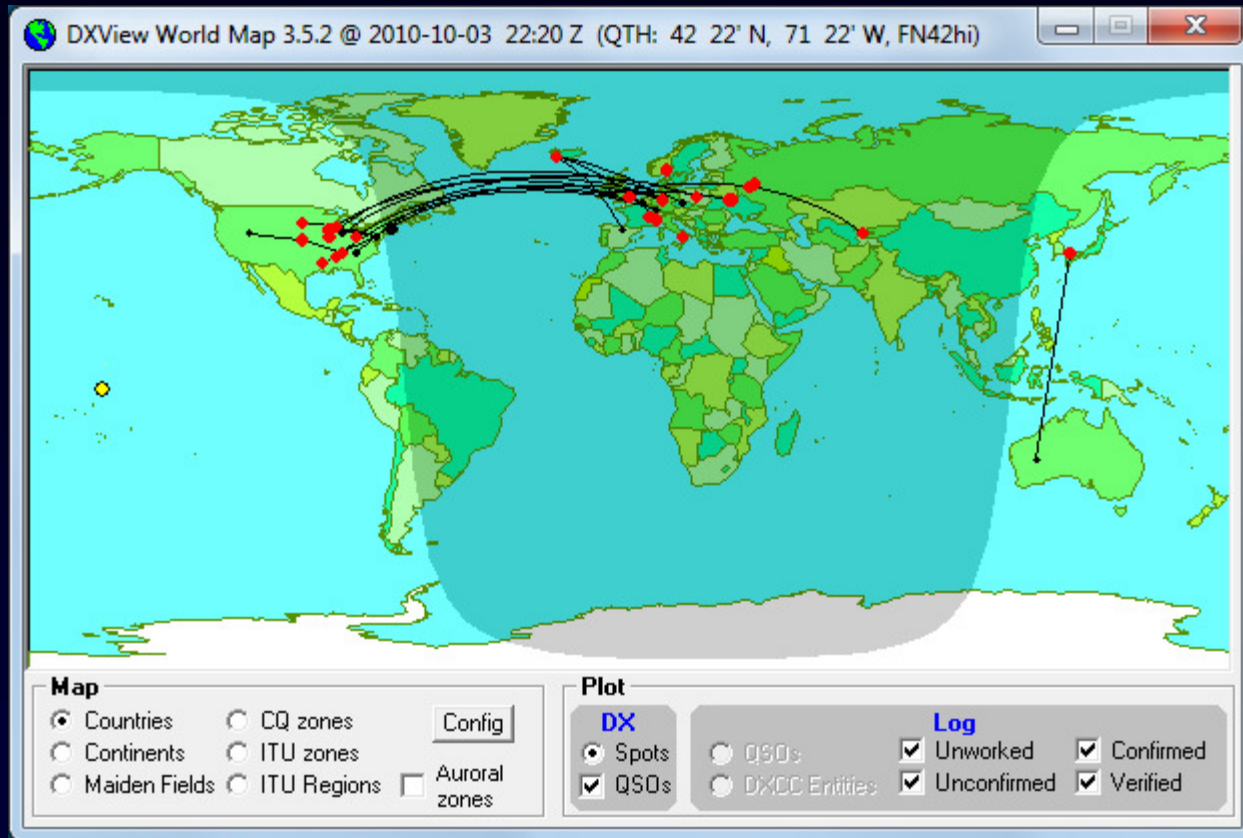

SpotCollector: Plotted 20m DX

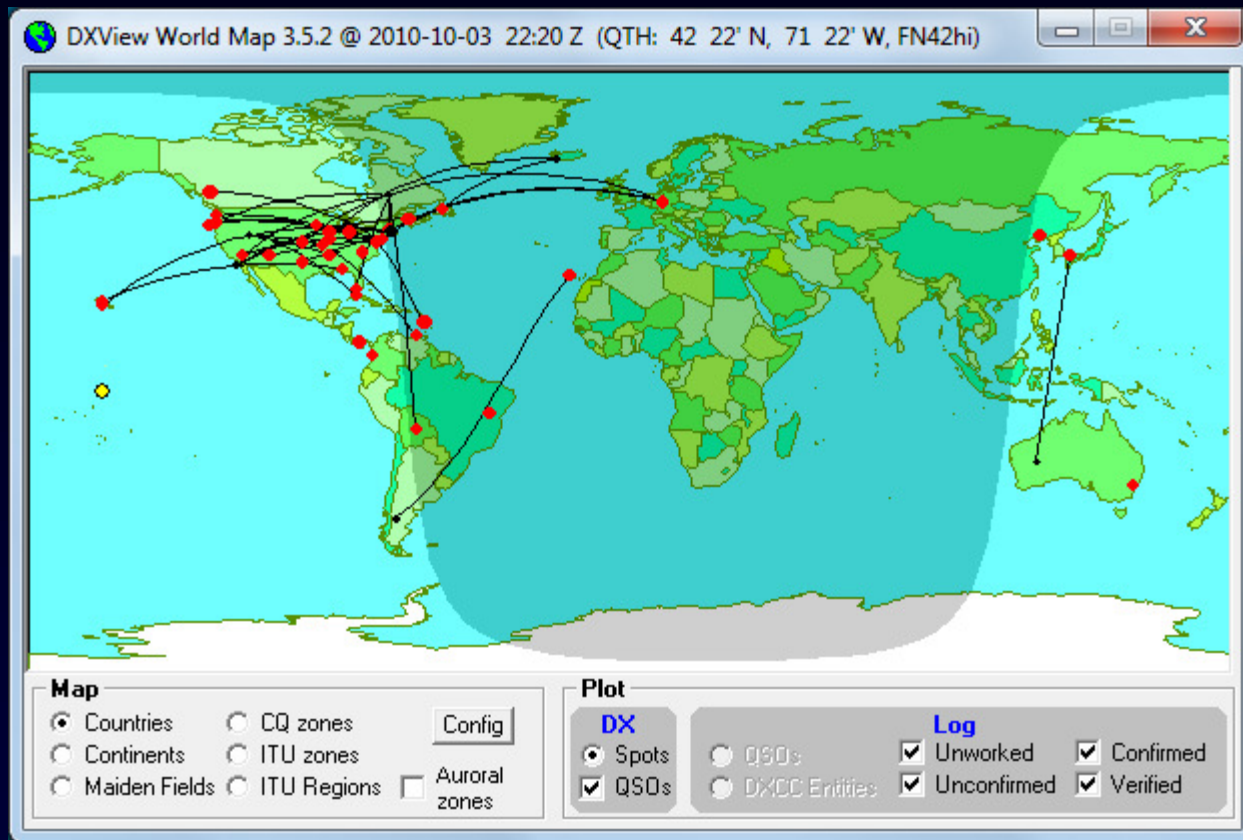

SpotCollector: Plotted 17m DX

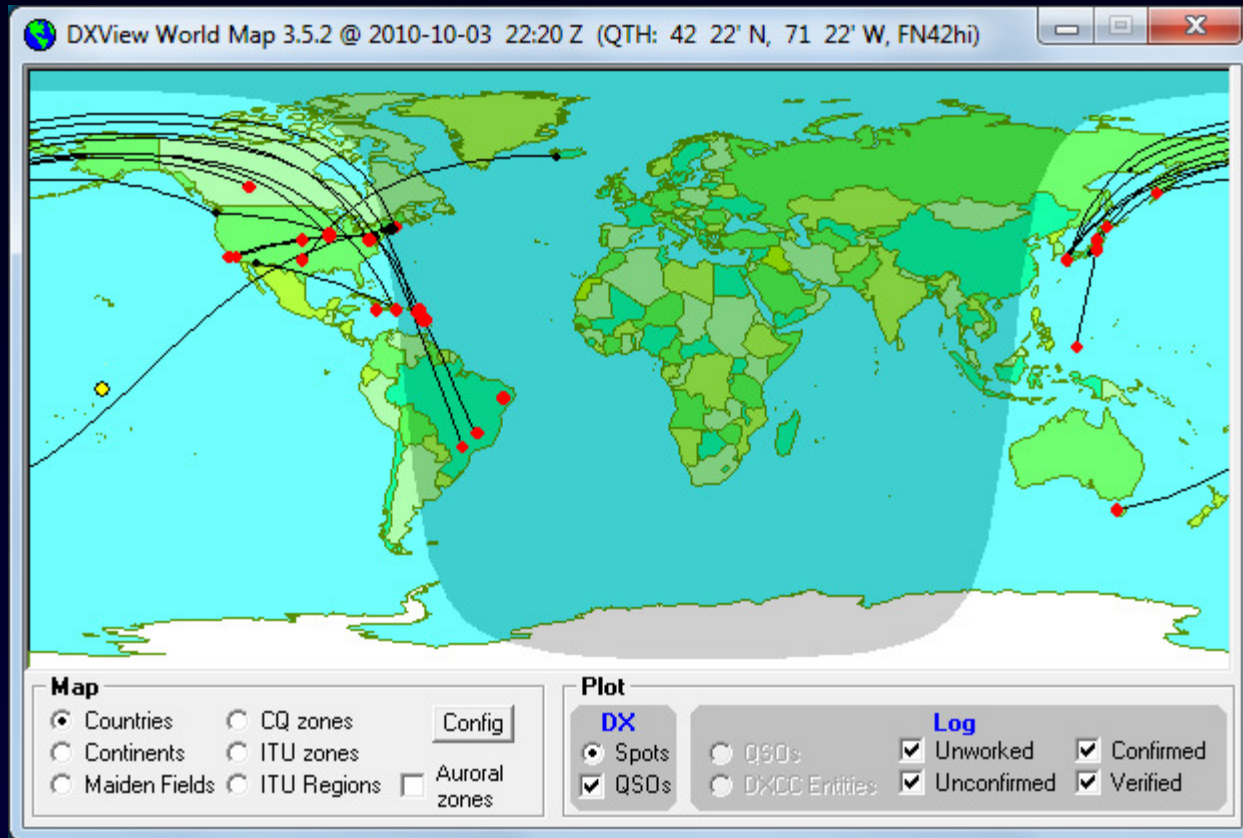

SpotCollector: Plotted 15m DX

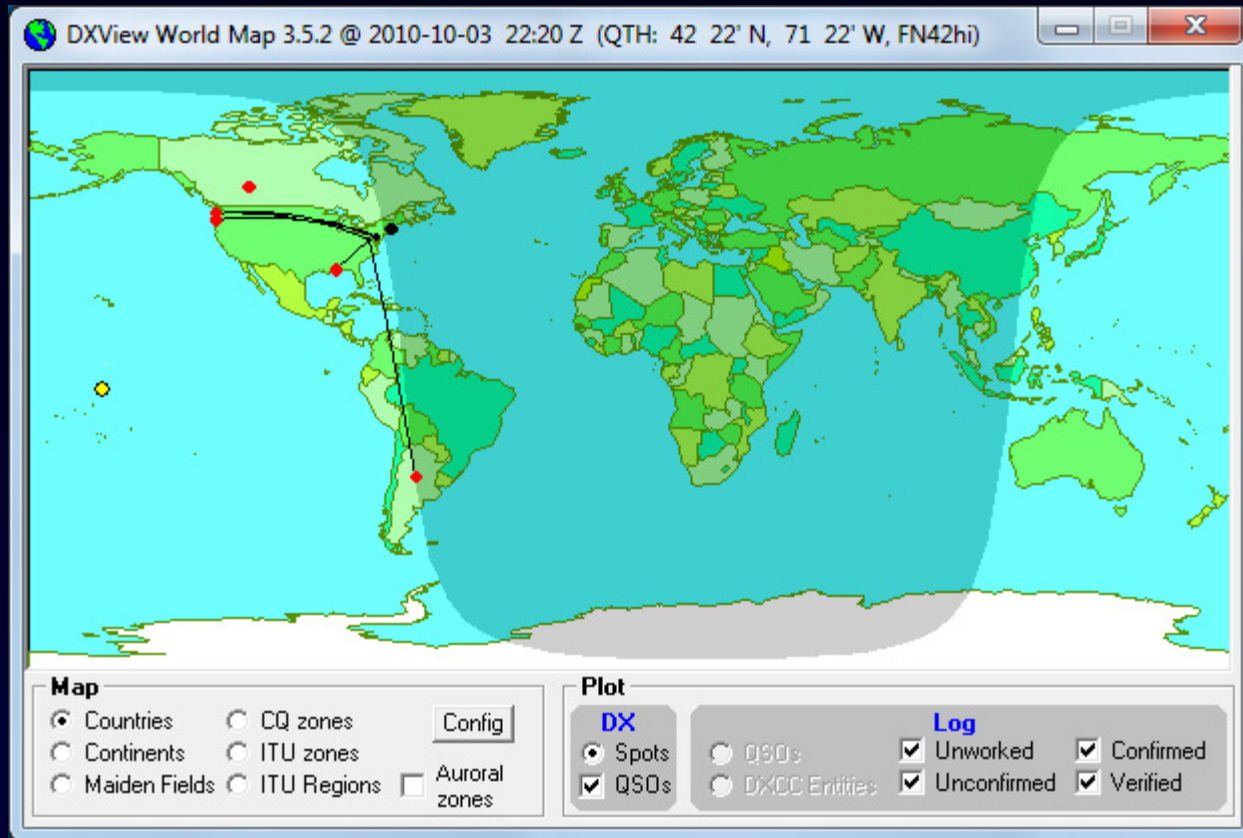

SpotCollector: Plotted DX spotted from NA-E

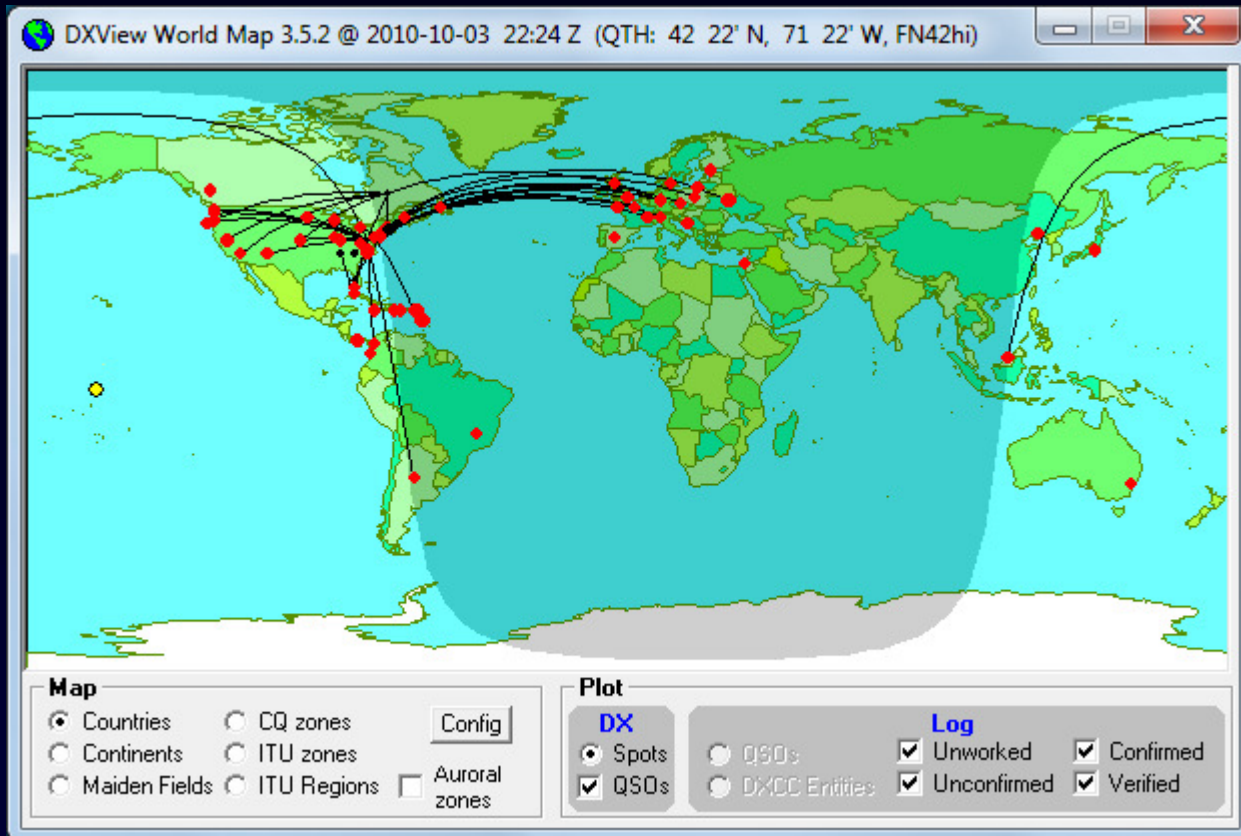

SpotCollector: DX on Commander's Bandspread

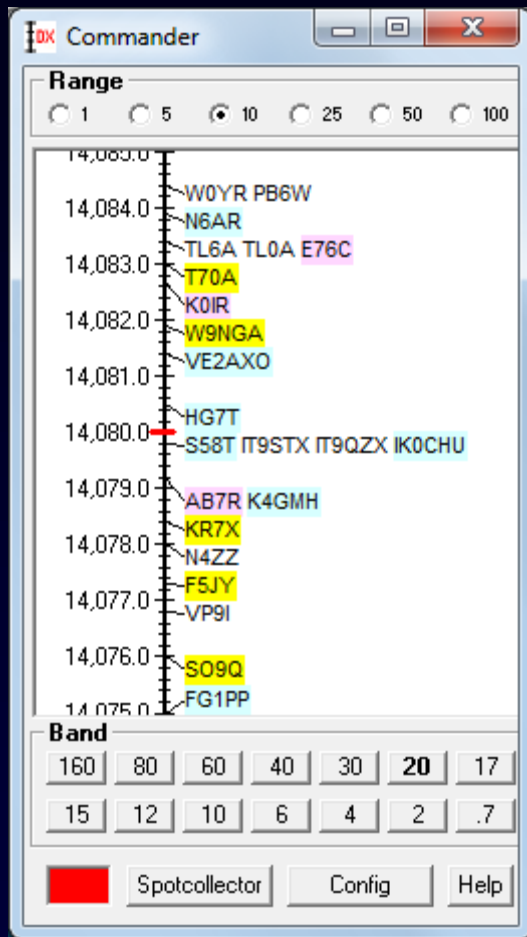

SpotCollector: DX on Commander's Bandspread

The screenshot shows the SpotCollector application window titled "DX Commander". The interface includes a "Range" section with radio buttons for 1, 5, 10, 25, 50, and 100, where 50 is selected. The main display area shows a vertical frequency scale from 14,100.0 to 14,055.0 kHz. Call signs are listed next to their frequencies, with several highlighted in yellow. A red horizontal line is positioned at approximately 14,080.0 kHz. Below the frequency list is a "Band" section with buttons for 160, 80, 60, 40, 30, 20, 17, 15, 12, 10, 6, 4, 2, and .7, with "20" selected. At the bottom, there are three buttons: a red button labeled "Spotcollector", a "Config" button, and a "Help" button.

Range
 1 5 10 25 50 100

14,100.0 PB6W
KS0AA EB1LA PD1KSA N5RN EB1LA MD2C
14,100.0 EA4ATS MD2C YT7W DQ4W
4B1EE FR G3VAO DR10TCC KK9A
W4TMO K2QMF FM5CD
14,095.0 G3V VE1OP D21ADL IT9BLB
JA1OVD CR6K IK5RUN LX7I
4CC IK4MGP E74KC LX7I MT0V
14,090.0 OP0P ED2V KT0R S50A ED2V P14CC WYTS
W1BV WA5ZUP
WX4TM PJ2S
14,085.0 GW4SKA LN9Z PB6W 6V7X N5TY
TL6A TLOA K0IR E76C T70A W0YR N6AR
W3NGA VE2AXO
14,080.0 S58T IT9STX IT9QZX AB7R HG7T IK0CHU
N4ZZ KRTX K4GMH
VP3I S09Q F5JY
14,075.0 EE3Y FG1PP VETUF
WP3C
14,070.0 K3DIG
HI3TEJ TU5KC M6SRH LU8FJH CP1JZ
AE5E EE5AE W6AEA UA4ET AE5A UU4UHI
14,065.0 WY3P
HG1S SS8VI
3ATT
14,060.0 T4HIIHEI C08ZZ WBSZ K5JNX
KD8AZO IS0B VA3SWG
14,055.0 KB3VTM W1DB

Band
160 80 60 40 30 20 17
15 12 10 6 4 2 .7

Spotcollector Config Help

SpotCollector: DX on Commander's Bandspread

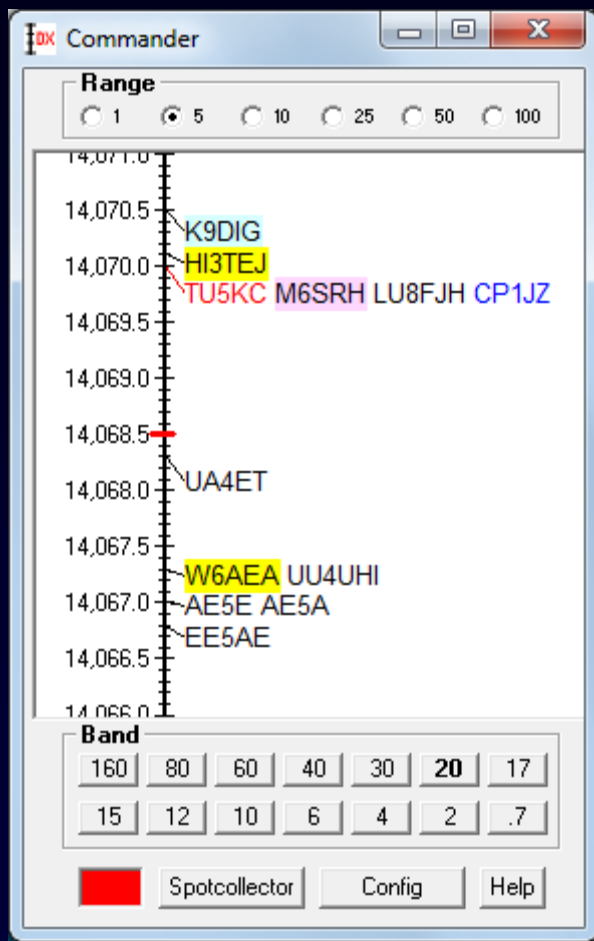

SpotCollector: DX Spot Database

- Double-click Database, Map, or Bandspread to
 - QSY the transceiver (freq, mode, split, dual rcv, QSX)
 - Rotate the antenna
 - Populate
 - DXKeeper's Capture window
 - WinWarbler's QSO Info panel
- Announces needed spots via the soundcard
- Tracks statistics
 - by band
 - By continent
- Built-in web server for local spot distribution

SpotCollector: Built-in Web Server



Droid Does DX!

SpotCollector: Messages & Announcements

The screenshot shows the SpotCollector 4.4.0 application window. The title bar reads "DX Central @ 3/28/2008 2223 Z [SpotCollector 4.4.0: connected]". A "Disable Autoscroll" button is located in the top right corner of the main window. The main text area contains a list of messages:

```
To ALL de DL8BED: when going 5T5DC QRT ????
```

```
To ALL de SV1EML: DL8BED SUNDAY
```

```
To ALL de PY7ZZ: T05RZ:10 and 12 meters should be great !!!
```

```
To ALL de RV3DHC: EK8PL via SP9LJD
```

```
To ALL de DJ1AA: DL20B0: Hi Obo, willkommen.. Bist Du im WPX QRV am Wochenende ?
```

```
To ALL de IW9FDD: DXCLUSTER :- iw9fdd.homeip.net:9000          Id At 19:57
```

```
To ALL de RA4UVK: QSL recvd VP6TD, YS3/I2JIN tnx!!!
```

```
To ALL de GB7UJS: CLUSTER: GB7UJS telnet 83.104.58.62 on port 7373          ID
```

```
at 2000Z on 28-Mar-2008
```

```
To ALL de SP1LOP: SR1DXZ DXCluster telnet://www.srlbsz.ampr.org:9000
```

```
To ALL de SP1LOP: SR1DXZ DXCluster: http://www.srlbsz.ampr.org/cgi-bin/dxnet.cgi
```

```
To ALL de IK7XLU: pse log online T05RZ?
```

```
To ALL de W5GZ: TNX fer setting all my bells off for the T05 on 10.. It is ZP!!!!
```

```
To ALL de LU9DA-6: LUCC DXCluster LU9DA-6 telnet://lu9da.dyndns.org:9000 28-Mar-2008
```

```
2037Z
```

```
To ALL de YV5A: PLS LOOK FR US IN THE WPX TEXT, YW4M, MULTI MULTI
```

```
To ALL de GB7CGL: GB7CGL AR-Cluster - telnet gb7cgl.ath.cx (ports 23, 6000, 7300 & 7373)
```

```
To ALL de TI8II: ZL2IFB yeap it was me ,but not reply from VK9 station
```

```
To ALL de F8CSB: CQ CQ
```

Below the message list is a "Macros" configuration panel with buttons for ALT F5 through ALT F12. The "ALT" button has a checkmark. There are also "Disconnect", "Help", and "Config" buttons.

SpotCollector: WWV Spots (all parameters)

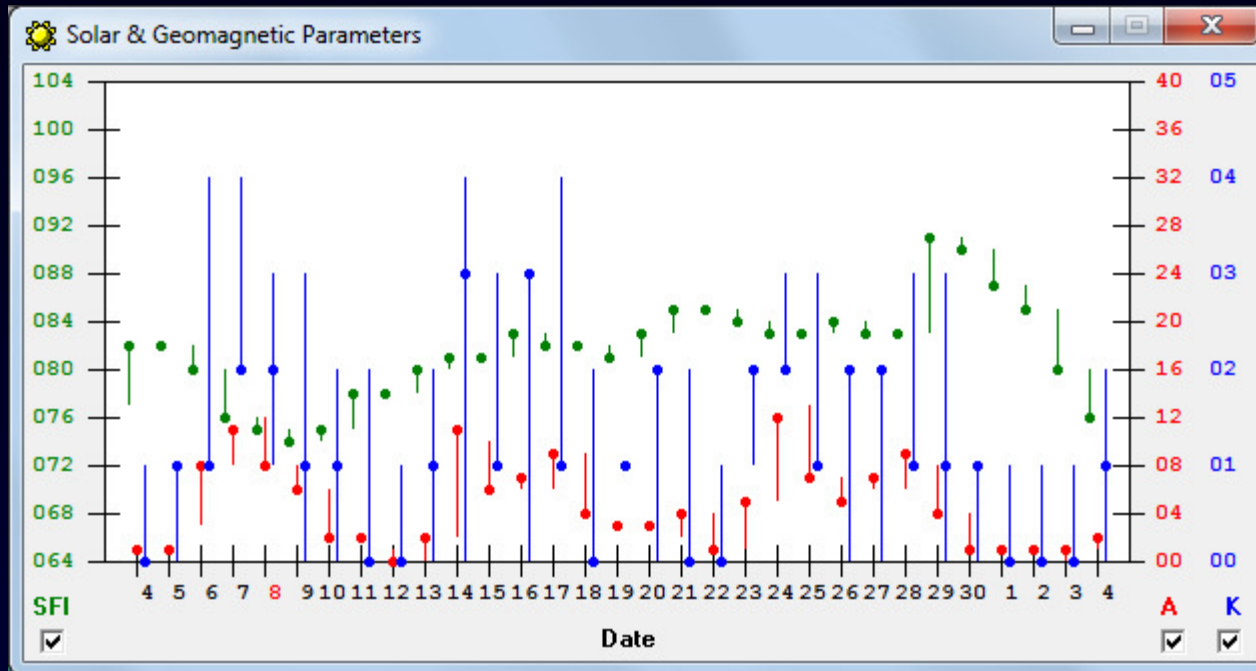

SpotCollector: WWV Spots (SFI & A only)

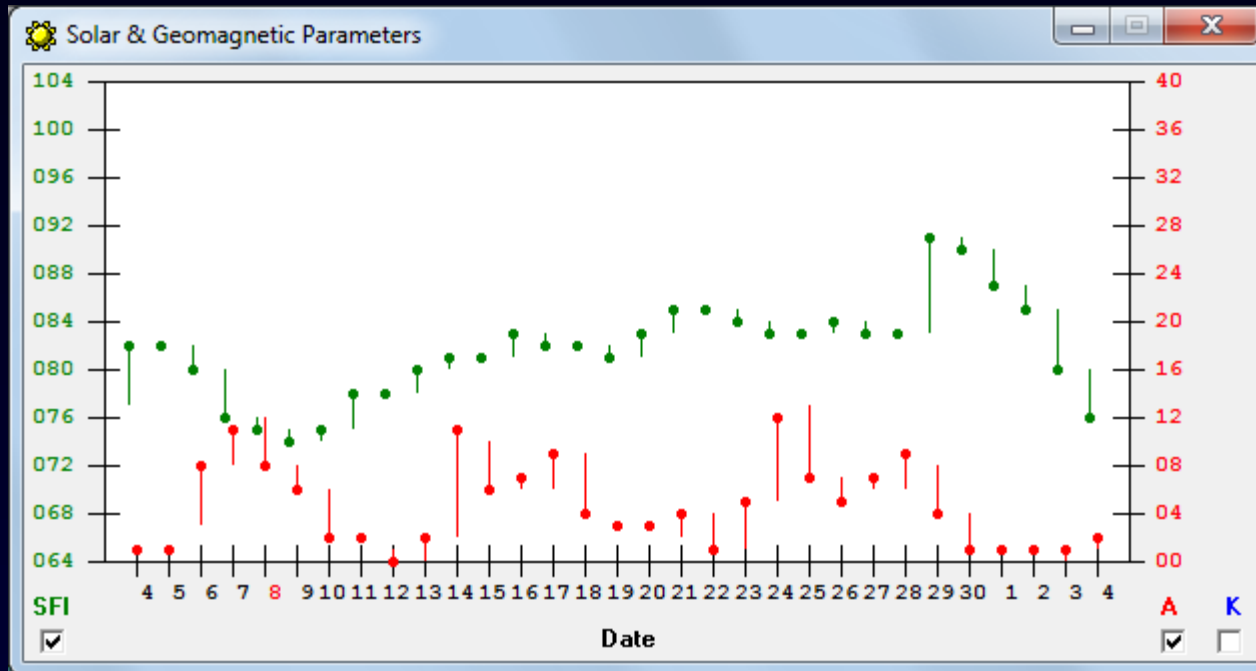

the DXLab Suite

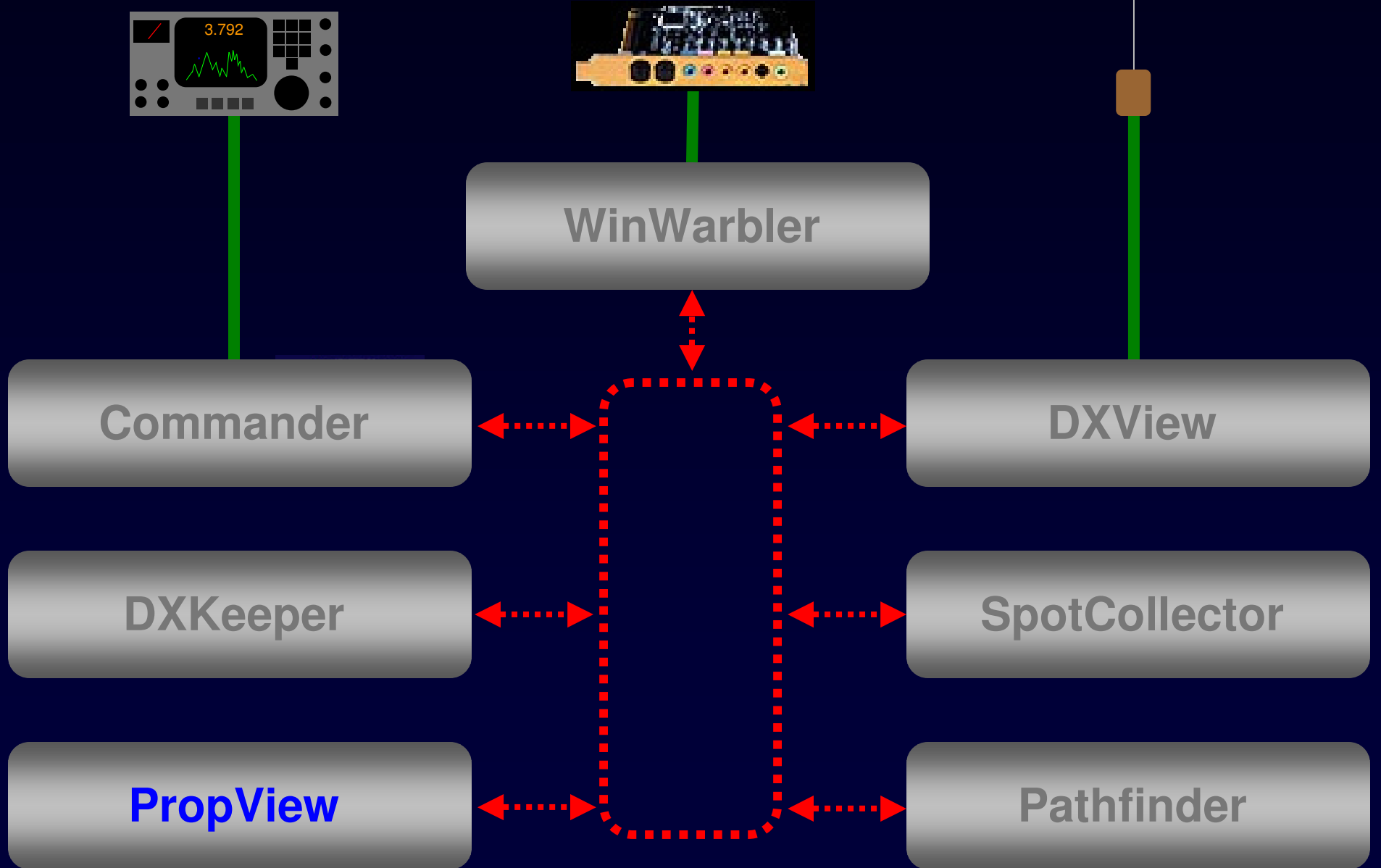

PropView

- Predicts propagation
- Monitors propagation

PropView: Propagation Prediction

- Includes three prediction engines
 - ICEPAC
 - IONCAP
 - VOACAP
- Gets solar flux and K-index from SpotCollector
- Gets locations from DXView
- Produces graphical prediction

PropView: Propagation Prediction

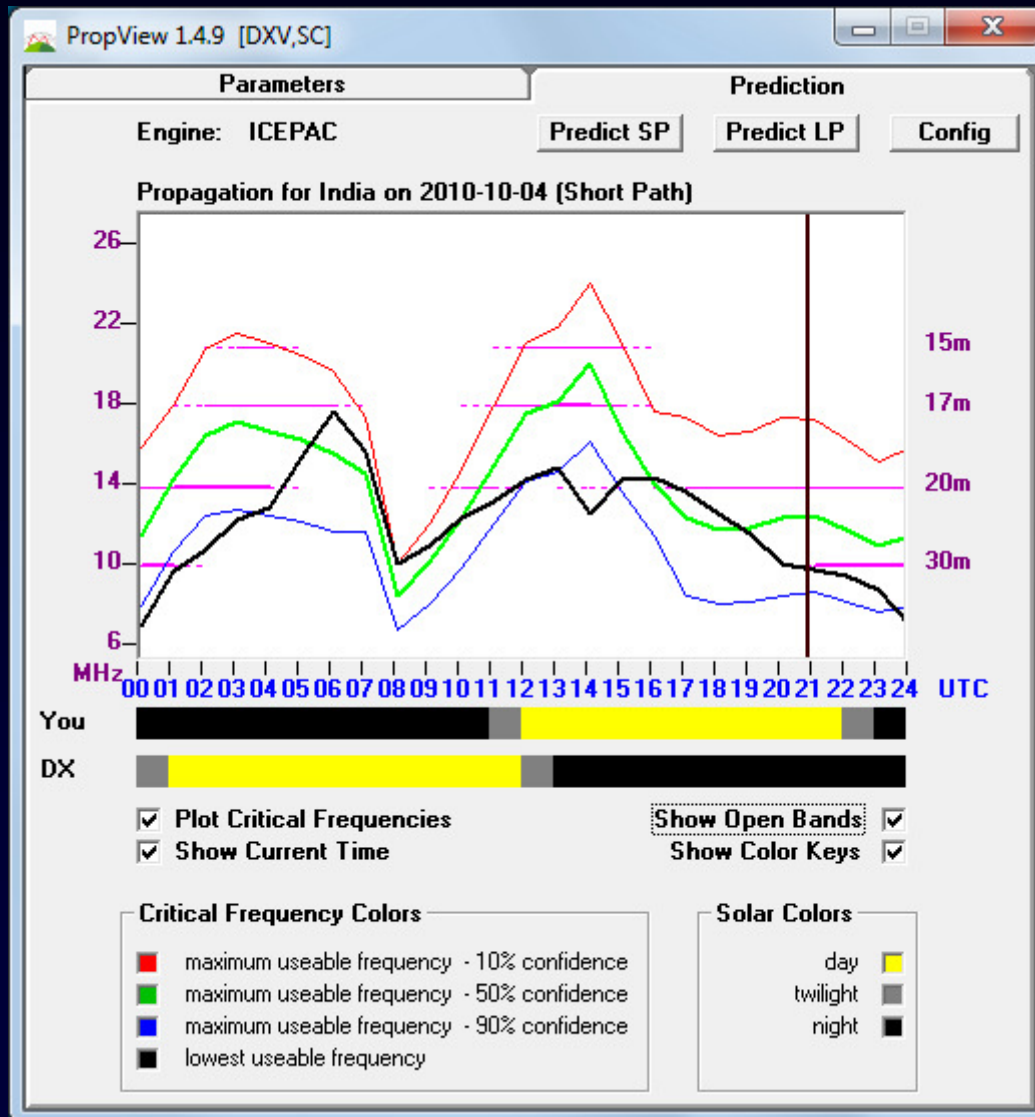

PropView: Propagation Prediction

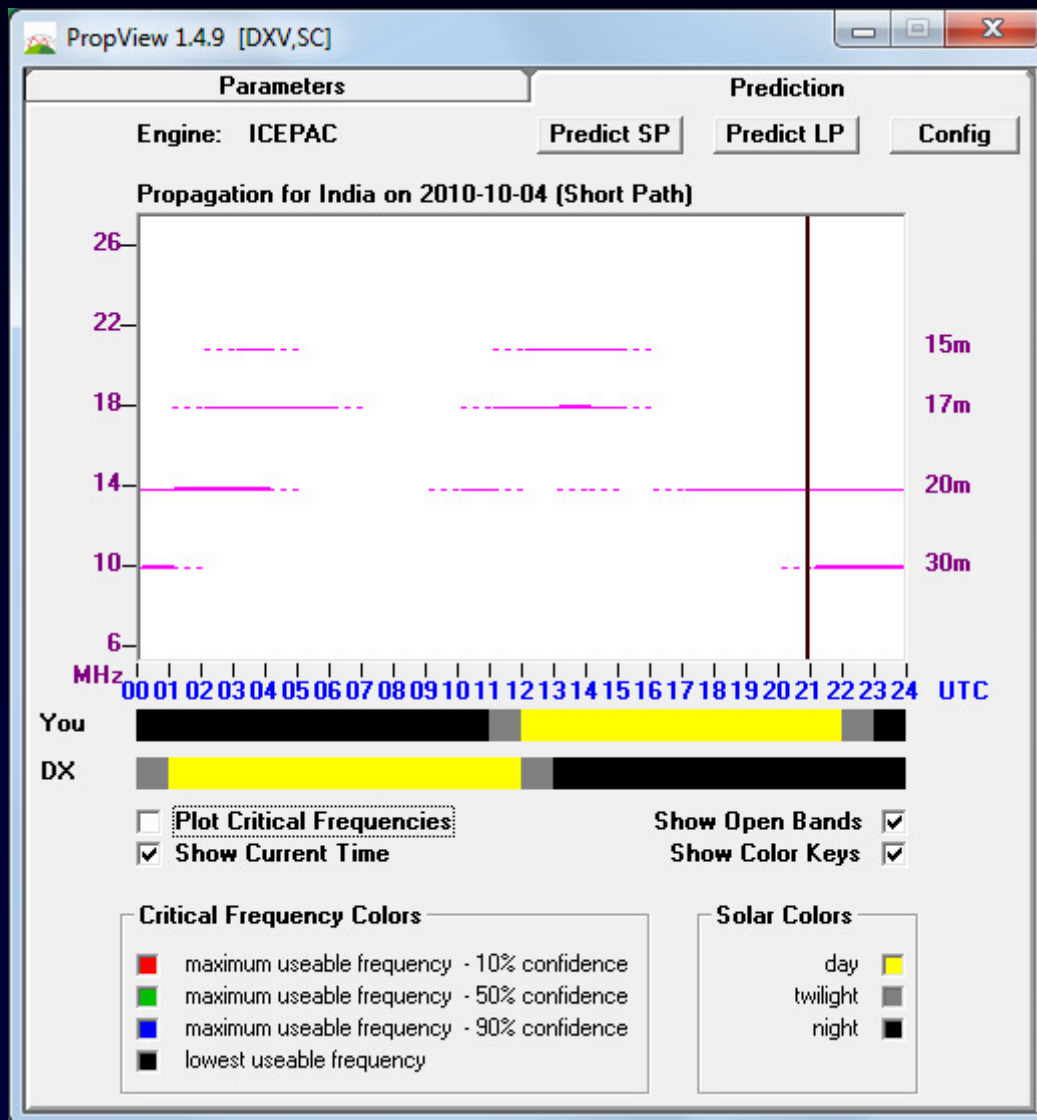

PropView: Propagation Monitoring

- Monitors NCDXF/IARU beacon network
- Builds beacon schedules
 - by band
 - by bearing
 - by specified beacons
- QSYs transceiver per beacon schedule
- Rotates antenna per beacon schedule

PropView: Propagation Monitoring

PropView Beacon Monitor @ 20:57:45 04-Oct-2010 [DXV,SC]

Monitor

Enable QSY Map

Band	Beacons	Octant	Transceiver
<input type="radio"/> 20m	<input type="checkbox"/> 4S7B <input type="checkbox"/> KH6W0 <input checked="" type="checkbox"/> VK6RBP	<input type="radio"/> 315 <input type="radio"/> 0	<input type="text" value="0"/> Offset (Hz)
<input type="radio"/> 17m	<input type="checkbox"/> 4U1UN <input checked="" type="checkbox"/> LU4AA <input type="checkbox"/> VR2B	<input type="radio"/> 270 <input type="radio"/> 45	
<input type="radio"/> 15m	<input type="checkbox"/> 4X6TU <input type="checkbox"/> OA4B <input type="checkbox"/> W6WXX	<input type="radio"/> 225 <input type="radio"/> 90	
<input type="radio"/> 12m	<input checked="" type="checkbox"/> 5Z4B <input type="checkbox"/> OH2B <input type="checkbox"/> YV5B	<input type="radio"/> 180 <input type="radio"/> 135	
<input type="radio"/> 10m	<input type="checkbox"/> CS3B <input type="checkbox"/> RR90 <input type="checkbox"/> ZL6B		
	<input type="checkbox"/> JA2IGY <input type="checkbox"/> VE8AT <input checked="" type="checkbox"/> ZS6DN	<input type="checkbox"/> Rotate	

Beacon Schedule (1 cycle)

Time	Call	City	DXCC Country	Freq (kHz)	SP	Dist (mi)
0						
10	VK6RBP	Rolystone	Australia	14100	327	11619
20	VK6RBP	Rolystone	Australia	18110	327	11619
30	VK6RBP	Rolystone	Australia	21150	327	11619
40	VK6RBP	Rolystone	Australia	24930	327	11619
50	VK6RBP	Rolystone	Australia	28200	327	11619
60	ZS6DN	Pretoria	South Africa	14100	104	7871
70	ZS6DN	Pretoria	South Africa	18110	104	7871
80	ZS6DN	Pretoria	South Africa	21150	104	7871
90	ZS6DN	Pretoria	South Africa	24930	104	7871
100	ZS6DN	Pretoria	South Africa	28200	104	7871
110	LU4AA	Buenos Aires	Argentina	14100	169	5382
120	LU4AA	Buenos Aires	Argentina	18110	169	5382
130	LU4AA	Buenos Aires	Argentina	21150	169	5382
140	LU4AA	Buenos Aires	Argentina	24930	169	5382
150	LU4AA	Buenos Aires	Argentina	28200	169	5382
160						
170						

the DXLab Suite

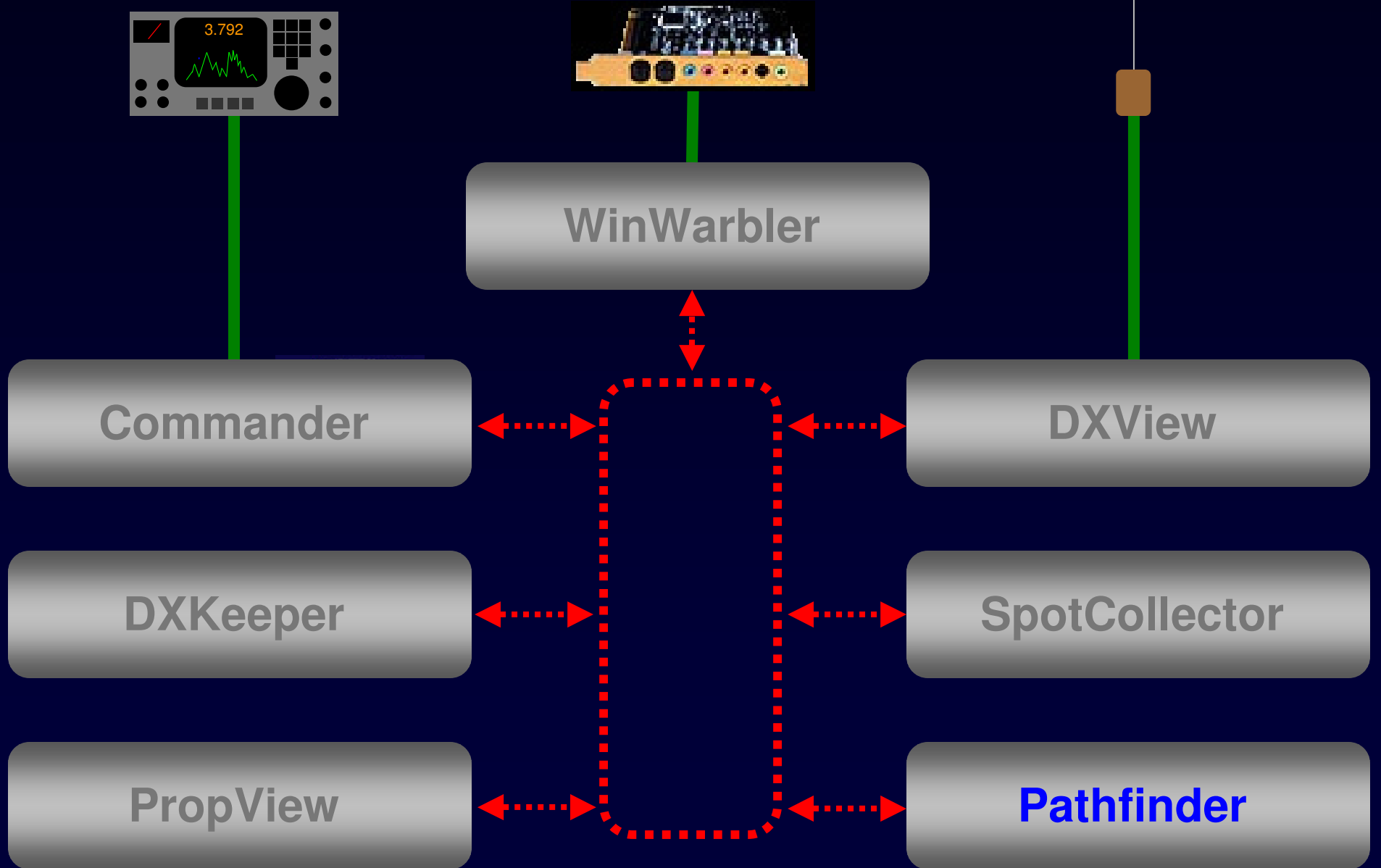

Pathfinder: QSO Information from the Web

- Sources
 - Country-specific callbooks (~80)
 - QSL sites (~40)
 - DX Summit spot archives
- 12 user-assignable search keys
- Captures callsigns selected via
 - DXView
 - DXKeeper
 - WinWarbler
 - SpotCollector

Pathfinder

Pathfinder 4.7.6: results from VK Callbook for VK3ZL

2010 X HC VK3ZL Buck QRZ IK3QAR DXC OZ7C R 1 X 1 Config

← RAC VK CB eHAM DB0SDX 425DXN Google OZ7C IM Daily DX Help

acma.gov.au

Register of Radiocommunications Licences

Client Details

Client Number	128363
Contact Name	Robert William Briggs
Postal Address	11 Turnley St MERINO VIC 3310

[\[New Client Search \]](#)

Licences Held

Results 1 - 1 of 1 licences.

Licence No	Licence Type	Licence Category	Callsign	Ship name	Status
182834	Amateur	Advanced	VK3ZL		Issued

the DXLab Ecosystem

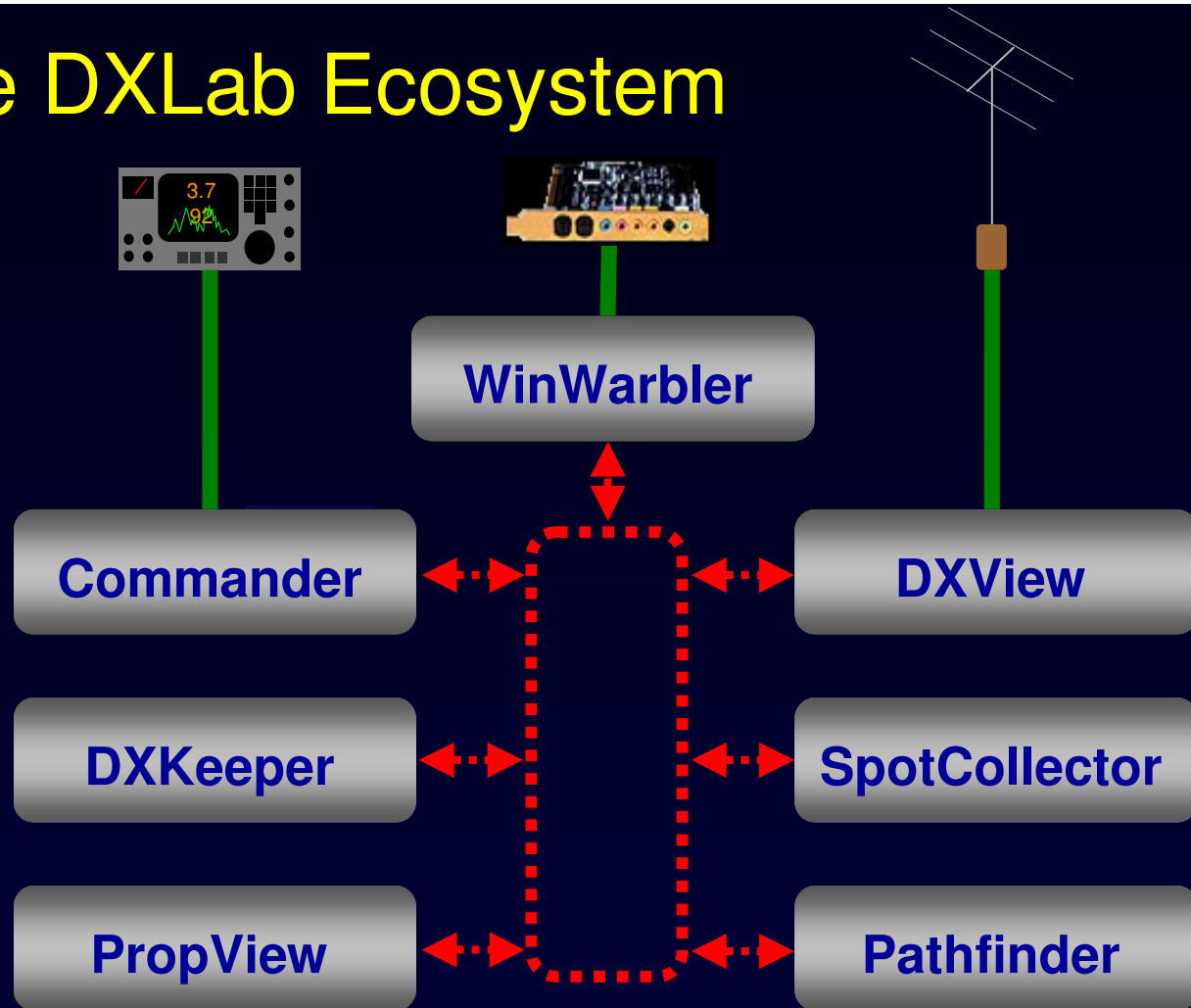

the DXLab Ecosystem

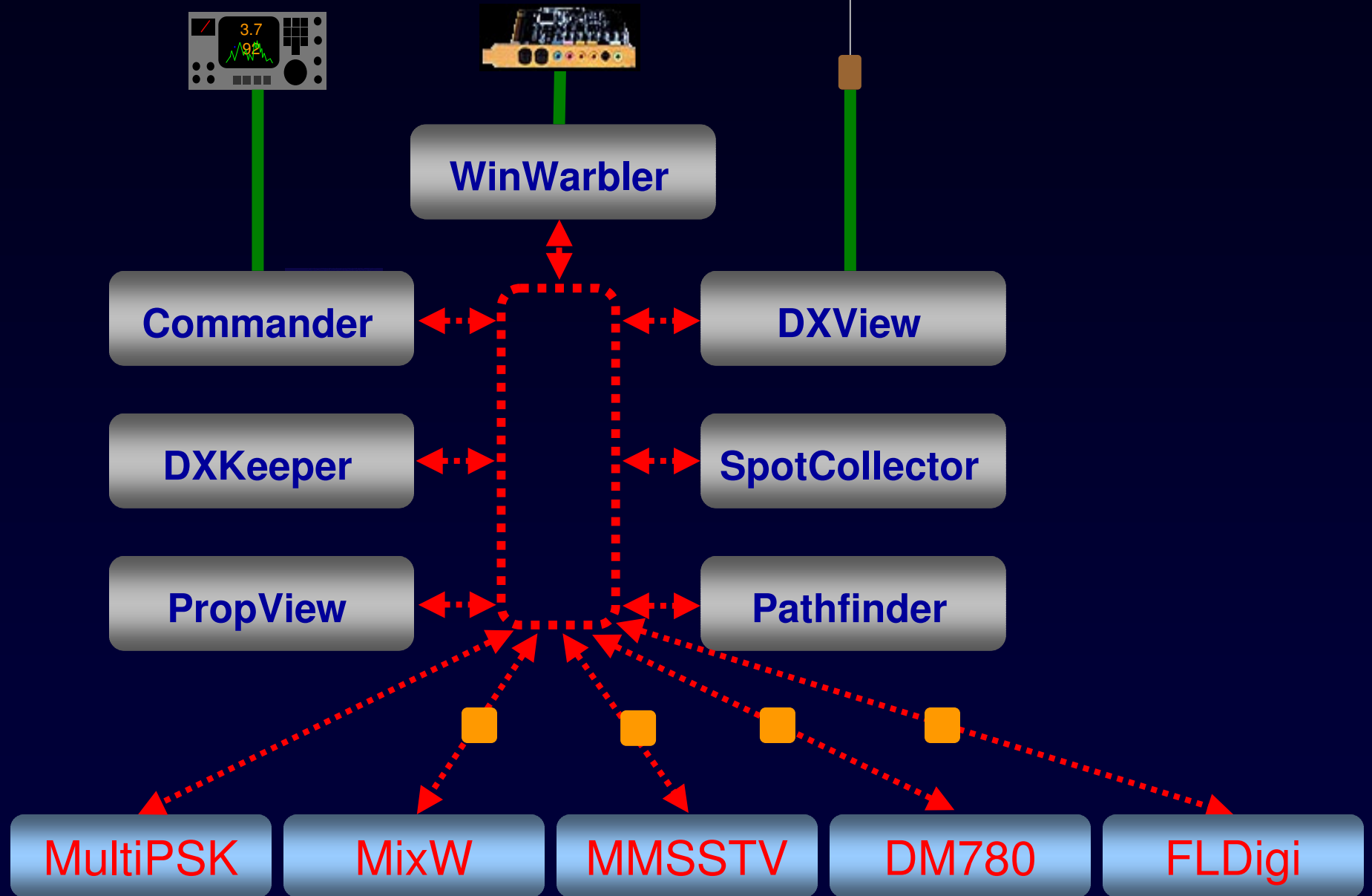

the DXLab Ecosystem

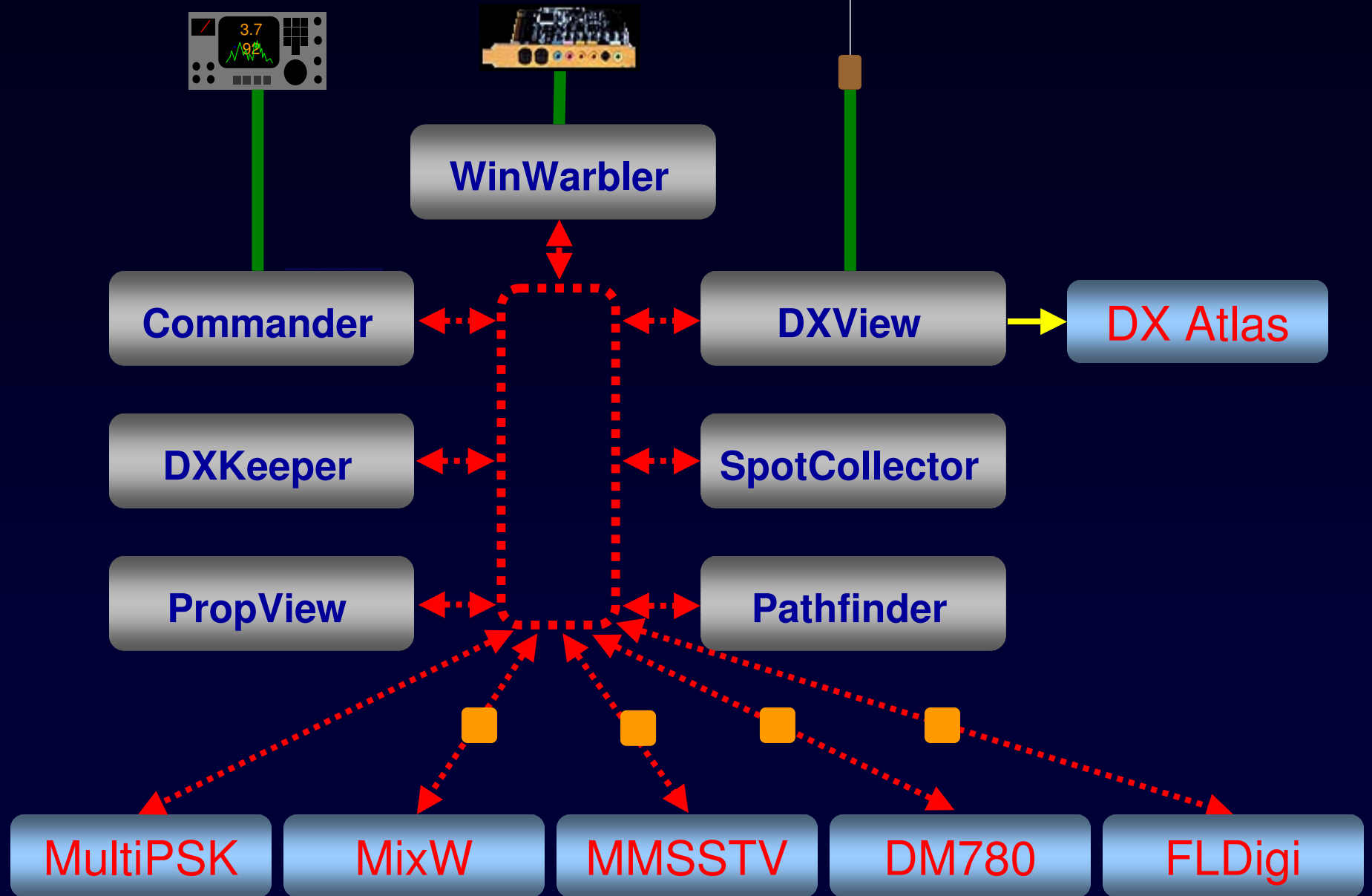

the DXLab Ecosystem

Interoperation

- MultiPSK
- MMSSTV
- MMVARI
- CWSkimmer
- DM780
- FLDigi
- IZ8BLY Hellschreiber
- Ham Radio Deluxe
- N1MM and N1MM Rotor
- WinContest
- DX Atlas(\$)
- LP StepLink (\$)
- MixW(\$)

Add-ins

- Alpha 87a control
- BMUtil
- CW Skimmer
- DXLPlus
- Frequency/S-meter display
- HamSked DXing calendar
- SpotSpy
- Web-site generation

DXLab: Continuing Development

- DXKeeper
 - More realtime award tracking
- WinWarbler
 - Improve MMTTY's RTTY decoder
 - CW decoding
 - Additional digital modes
- PropView
 - Long-term beacon analysis
 - Increase Solar Flux!

DXLab: Prerequisites

- Minimum (1 application)
 - 133 MHz Pentium
 - 64 MB DRAM
 - 800x600 SVGA monitor
 - Windows 98SE
- OK (all applications)
 - 600 MHz Pentium 2
 - 512 MB DRAM
 - 1280x1024 XVGA monitor
 - Windows 2000 or Windows XP
- Optimum (all applications)
 - 2 GHz dual-core
 - 2 GB DRAM
 - 1600x1200 XVGA monitor or multiple smaller monitors
 - Windows XP, Windows Vista, Windows 7 (32-bit or 64-bit)

www.dxlabsuite.com/download.htm

Downloading and Installing DXLab Applications

DXLab applications run on **Windows NT, 2000, XP, Vista, and 7** in both 32-bit and 64-bit flavors. Some DXLab applications can be individually run on **Windows 95, 98, and 98SE**.

Using virtual machines, DXLab applications can also be run on **Linux** and **Macintosh**:

- [DXLab on Linux](#)
- [DXLab on Macintosh](#)

Getting Started with DXLab

- [Documentation](#)
- [Availability Announcements](#)
- [Bridges, Gateways, and Extenders](#)
- [Distribution Sites](#)
- [Articles and Presentations](#)
- [DXLab Reflector](#)

Before installing your first DXLab application, install the Launcher

The [DXLab Launcher](#) automates the installation of new DXLab applications and the upgrading of already-installed DXLab applications. If you're an aspiring DXLab user who has not installed any DXLab applications on your PC, or if you're a long-time DXLab user who has never installed the Launcher, then installing the Launcher will make it easy to install new DXLab applications and keep them up to date as upgrades are released. Clicking the **Install Launcher** button below will download and install the DXLab Launcher on your PC. Step-by-step guides to installing the Launcher are available in [HTML for browsing](#) and in [PDF for printing](#).

Do not click the **Install Launcher** button if the Launcher is already installed on your PC. If you're not sure, [here's how to check](#).

If the Launcher is already installed on your PC, you should [determine if a newer version is available](#) and, if so, [upgrade](#) it.

By default, each DXLab application will be installed in a subfolder of

```
c:\dxlab
```

but you can specify an alternate location if desired. The Launcher will ensure that each DXLab application is installed in a separate folder, e.g.

- c:\dxlab\dxkeeper
- c:\dxlab\winwarbler
- c:\dxlab\pathfinder

If you decide to install DXLab within c:\program files\ or c:\program files (x86) then

- If your PC is running Windows 7, login to an account with Administrator privileges to install or run DXLab applications
- If your PC is running Vista, [login to the account named Administrator](#) to install or run DXLab applications



DXLab: Better DXing Through Software

DXKeeper 8.9.4 [CC,DXV,SC,WW] - AA6YQ.mdb : 18487 QSOs

Log QSOs | QSL | Check Progress | my QTHs | Import QSOs | Export QSOs

QSO: Jordan

call JY4NE name QTH

mode RTTY via tx freq 14.086765 begin 9/20/2010 18:37

sent 599 rcvd 599 tx band 20M rx freq 14.086764 end 9/20/2010 18:37

power 1500 code 342 DXCC JY entity Jordan

Call	DXCC	Starting UTC	Band	Mode	Sent	Rcvd	Name
JT5DX	JT	9/19/2010 23:23	17M	CW	599	599	hadraabal
PK0AT	UA	9/20/2010 01:01	20M	RTTY	599	599	Vit
KP4JFR	KP4	9/20/2010 01:11	20M	RTTY	599	599	Jose
JY4NE	JY	9/20/2010 18:37	20M	RTTY	599	599	

SpotCollector 5.3.9 @ 2010-10-04 19:59 Z [CC,DXK,DXV,WW] (log: AA6YQ.mdb)

WVWV 10-04 1806 Z

Outgoing spot: Call 14,086.2 Freq Cluster

Callsign	Pfx	Freq	Band	Mode	LastTime	Notes	NAE	NAM	NAW	SA	EU	AF	AS	OC	UN	LastOrig	Source
PS7DX	PY	14,018.3	20M	CW	10/4/2010 19:59	CQ 8 dB 21 WPM	Y	Y	Y	Y	Y	Y	Y	Y	Y	NA-E	N4ZR-#
SQ9CNS	SP	3,541.0	80M	CW	10/4/2010 19:59	CQ 16 dB 13 WPM					Y					EU	DL5Q-#
LA3TQ	LA	14,017.8	20M	CW	10/4/2010 19:59	CQ 18 dB 23 WPM										EU	S5Z-#
IK0RCD	I	14,025.6	20M	CW	10/4/2010 19:59	CQ 13 dB 18 WPM	Y	Y	Y							NA-M	K8ND-#
3A/SP9EVP	3A	7,017.0	40M	CW	10/4/2010 19:59	CQ 21 dB 26 WPM					Y					EU	DL5Q-#
UA9MA	UA0	1,822.5	160M	CW	10/4/2010 19:59	CQ 10 dB 25 WPM					Y					EU	EI6IZ-#

DXView World Map 3.5.2 @ 2010-10-04 19:57 Z (QTH: 42 22' N, 71 22' W, FN42h)

Map: Countries, CQ zones, Continents, ITU zones, Maiden Fields, ITU Regions, Auroral zones

Plot: Spots, QSOs, DXCC Entities, Unworked, Confirmed, Unconfirmed, Verified

Log: AA6YQ.mdb

WinWarbler 6.8.5 for AA6YQ @ 2010-10-04 19:59 Z [CC,DXK,DXV,SC]

QSO Info (Receive Pane 0)

Call: EY7AD Name: Rakhim DXCC: EY Begin: Log: Xcvr Freq: 14,086.19

QSL: via DIRECT -1 CQ: 17 ITU: 30 QTH: 735700 Cont: AS End: Spot: Tx: 14,086.19

Buro: Grid: MN30 Pri sub: Sec sub: Comment:

LotW: IDTA: Az: Path: S

QU0THCQ DX CQ DX DE SV1PAS SV1PAS PSE K
 DS1PAUSSVPAS DEHPFF,PD1BPSE K...
))ITCQ DX CQ DX DE SV1PAS SV1PAS PSE EUU0E0SCQ DX CQ DX DE SV1PAS SV1PAS PSE K
 S MSOVAS UV1PAS DE PD1ANB,PD1ANB
 PSE K...9R2 QR2 QR2 DE SV1PAS SV1PAS PSE K

Commander 8.5.8 [Icom IC-7200] @ 19:59:42 Z 14,086.19 LSB

VFO A: 20M 14,086.19

VFO B: 21,008.10

Filters: Group normal Width 0 PBT 1 50 PBT 2 50

PTT: Rcvng TX RX

AL-1200 Plate 7.75 Load 4 Band 20

Mode: LSB (normal) FM (wide) USB (normal) AM (wide) CW (narrow) RTTY (wide) CW-R (narrow) RTTY-R (wide)

Commander Range

14,088.5

14,088.0 E17BFB

14,087.5 EA4AHE

14,087.0 UR7ITU

14,086.5 PF7DKW

14,085.5 LX8RTTY

14,084.5 SP9GKJ

14,084.0

Band: 160 80 60 40 30 20 17 15 12 10 6 4 2 .7

Spotcollector Config Help

Macros: rty sample

F5 CQ F6 Call F7 Over F8 SK log ALT F9 ur rpt F10 tu log grz? F11 de mgsall F12 mgsall (3)

80m 40m 30m 20m 17m 15m 12m 10m

sh F5 sh F6 sh F7 sh F8 sh F9 sh F10 sh F11 sh F12

RTTY receive (soundcard)

Freq: 14,084.065 Signal level & squelch 61

AFC Notch Profile Reverse Def Opt

RTTY transmit (soundcard)

Freq: 14,084.065 net

Reverse Start Stop Abort

Operating Mode

CW PSK31 Phone PSK63 RTTY PSK125

Tuning Display

Vert height 2.0 Horiz zoom 1 Horiz pan